

Espelho Orgânico Deco II

Espejo Organico Deco / Deco Organic Mirror
Versão 1.0 / Versión 1.0 / 1.0 Version

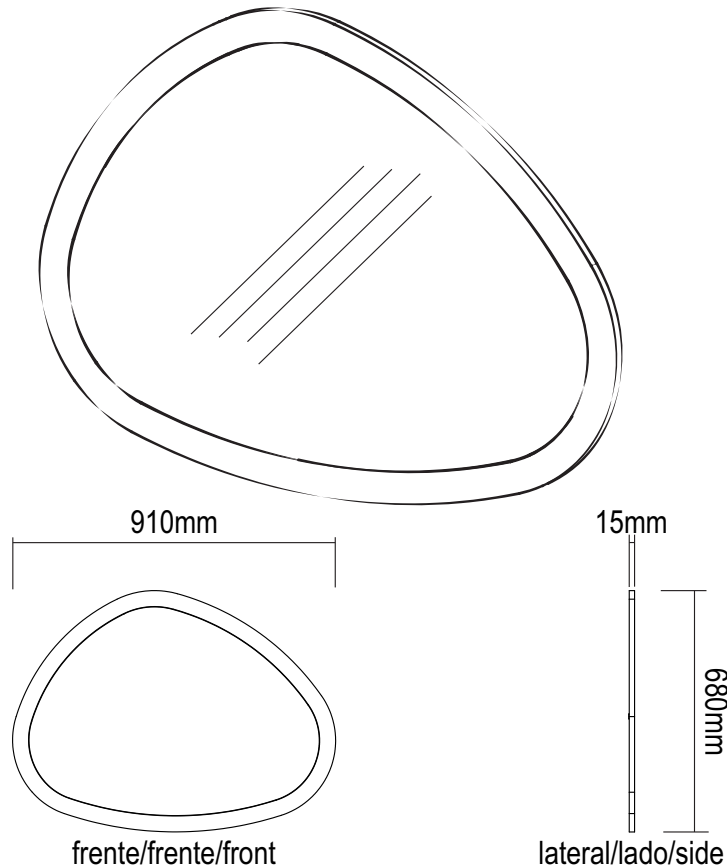

Conservação e Limpeza - Conservación y Limpieza - Conservation and Cleaning

Não expor o produto ao sol, altas temperaturas e umidade. Não arrastar objetos sobre a superfície do móvel (ex.: TV, equipamentos eletrônicos, objetos decorativos...). Manter em local seco e arejado. Para a limpeza, utilizar um pano seco e macio. Não é necessário o uso de materiais abrasivos ou álcool.

No exponga el producto a la luz solar, las altas temperaturas y la humedad. No arrastre los objetos en la superficie de la unidad (por ejemplo, TV, equipos electrónicos, objetos de decoración ...). Mantener en un lugar fresco y seco. Para la limpieza, utilizar un paño seco y suave. El uso de materiales abrasivos o del alcohol no es necesario.

Do not expose the product to sunlight, high temperatures and humidity. Do not drag objects across the surface of the unit (TV, electronic equipments, decorative objects ...). Keep it in a cool and dry place. For cleaning, use a dry and soft cloth. Do not use abrasive materials or alcohol.

Garantia

Este certificado de Garantia é uma vantagem adicional oferecida ao consumidor, porém para que o mesmo tenha validade é imprescindível que seja apresentada a NOTA FISCAL de compra do produto.

Com este produto, a **Artely** tem como objetivo atender plenamente o proprietário-consumidor, proporcionando a garantia na forma aqui estabelecida, pelo período de três meses a partir da data da nota fiscal de compra. A **Artely** restringe a sua responsabilidade à substituição gratuita das peças defeituosas, em caso de defeitos ou avarias devidamente constatados como sendo de fabricação, durante a vigência desta garantia.





A **Artely** declara a garantia nula e sem efeito se o produto for alterado, adulterado, molhado ou consertado e ainda pela prática de montagem inadequada ou mau uso. Também será considerada nula em casos de força maior, como aqueles causados por agentes da Natureza (chuvas, incêndios, excesso de umidade, cupins,...) e eventos externos como objetos arrastados sobre a superfície do móvel (ex.: TV, DVD, aparelho de som, objetos decorativos...).

Para exercer seus direitos de comprador é importante que antes de montar seu produto você leia com atenção as instruções de cada passo do manual de montagem que acompanha o móvel.

Caso o produto não esteja em conformidade, entre em contato com a loja onde efetuou a compra e faça sua reclamação, apontando os defeitos técnicos observados. Para agilizar o seu atendimento, tenha sempre em mãos o manual de montagem com os respectivos números das peças defeituosas, conforme descritas no manual.

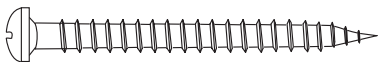
Lista de Materiais

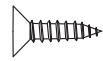
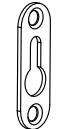
Lista de Materiales/ Hardware List

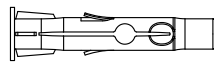
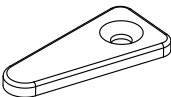
A	 	02 Parafuso / Tornillo / Screw Ø4,0x45mm CF
B	 	04 Parafuso / Tornillo / Screw Ø3,5x12mm CC Metal - Cabeça Philips
C		02 Chapa / Chapa / Plate 14x1,5x42mm Metal
D	 	02 Bucha / Casquillo / Bushing Ø6mm - Plástico
E		06 Tramela/ Trampa / Fastener 25x12 Plástico

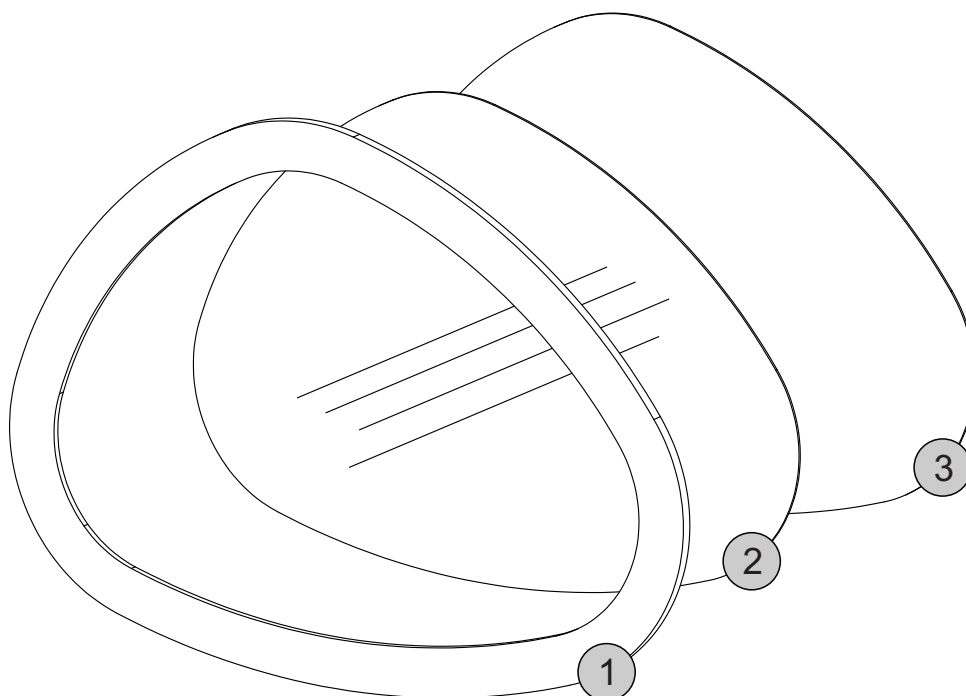

Descrição	Descripción	Description	Qtd
1-Moldura (910x680x15mm)	1-Marco	1-Frame	1
2-Espelho (818x588x3mm)	2-Espejo	2-Mirror	1
3-Traseira (818x588x3mm)	3-Trasero	3-Back	1

Passo 1

Paso/Step

PEÇA
Piece/Pieza

1 - MOLDURA x1

1 - ESPELHO x1

1 - TRASEIRA x1

FERRAGEM
Hardware/Herraje

B  04

E  06

FERRAMENTA
Tool/Herramienta

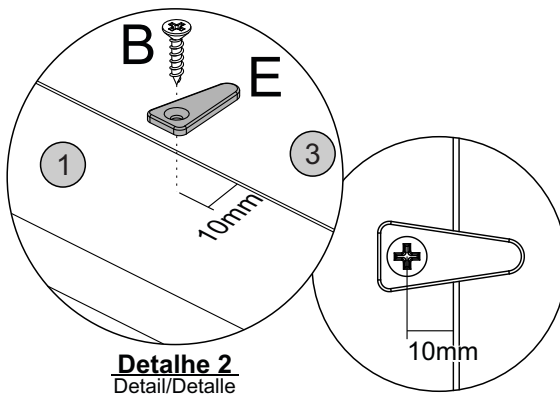
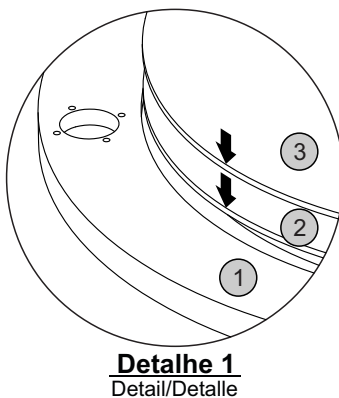
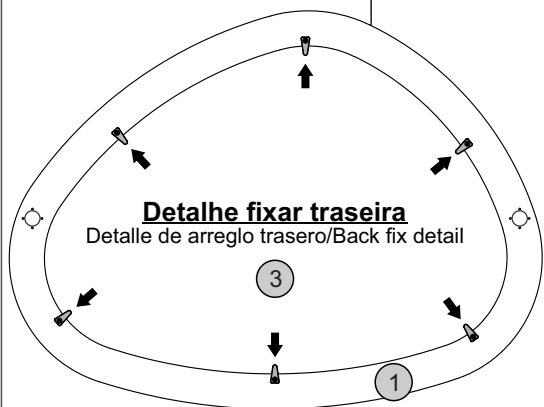
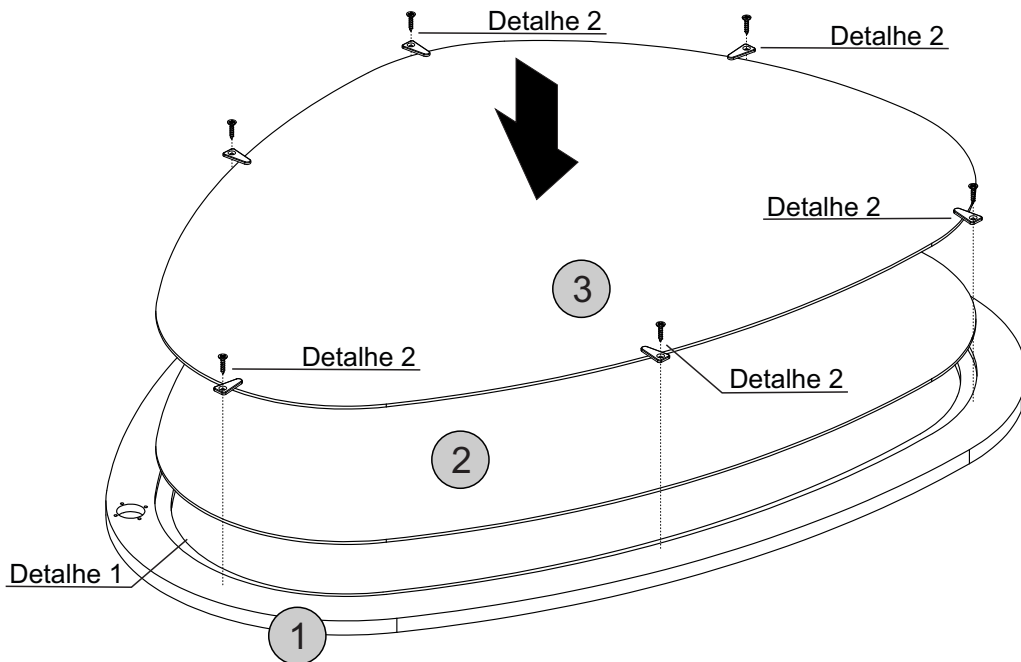
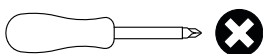

Opções de fixação

Opciones de fijación / Fastening options

Opção A

Opciones A / Options A

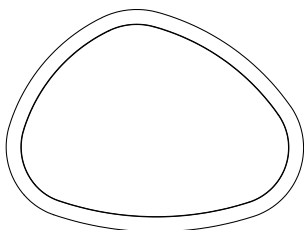

Opção B

Opciones A / Options A

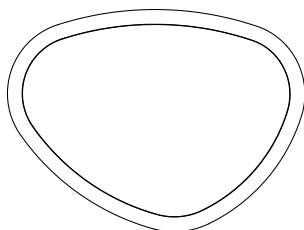

Opção C

Opciones A / Options A

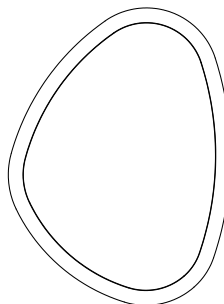

Opção D

Opciones A / Options A

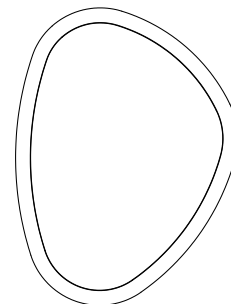

Opção A

Opciones A / Options A

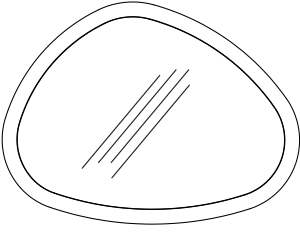

FERRAGEM
Hardware/Herraje

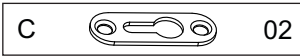
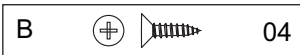

FERRAMENTA
Tool/Herramienta

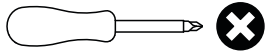

Detalhe 3

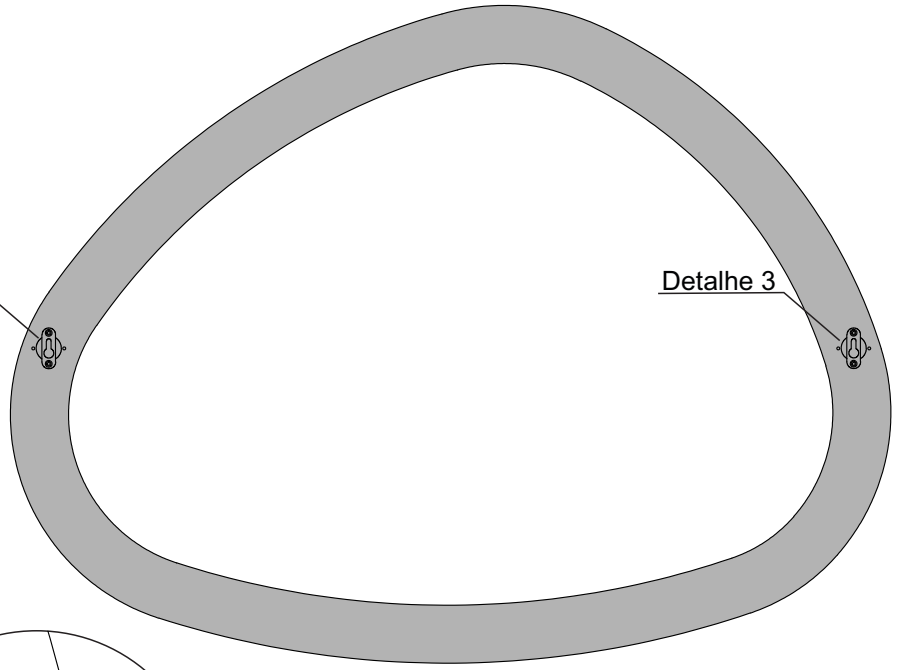

Detalhe 3

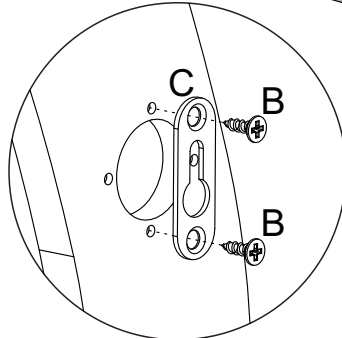

Detalhe 3
Detail/Detalle

Opção B

Opciones B / Options B

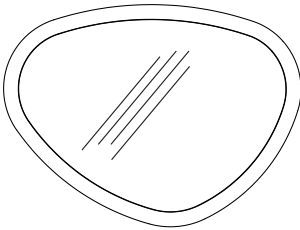

FERRAGEM
Hardware/Herraje

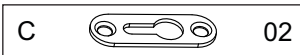
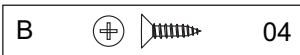

FERRAMENTA
Tool/Herramienta

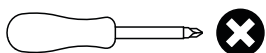

Detalhe 3

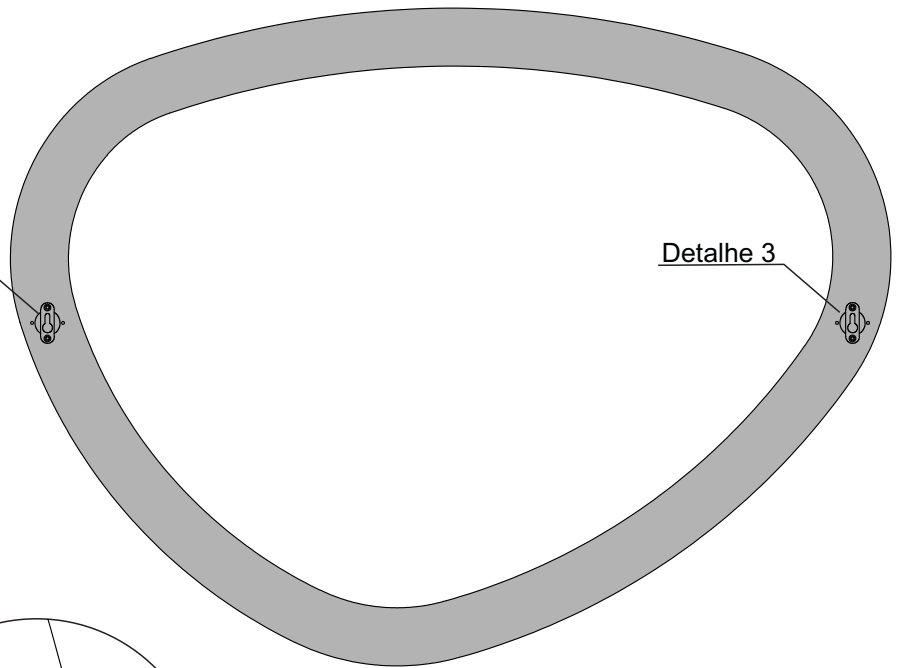

Detalhe 3

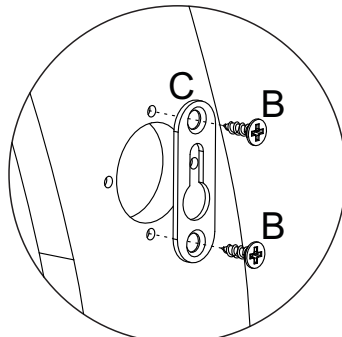

Detalhe 3
Detail/Detalle

Opção C

Opciones C / Options C

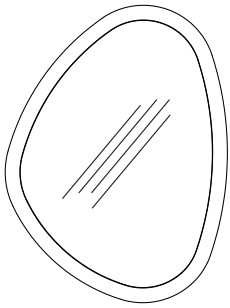

FERRAGEM
Hardware/Herraje

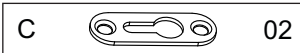

FERRAMENTA
Tool/Herramienta

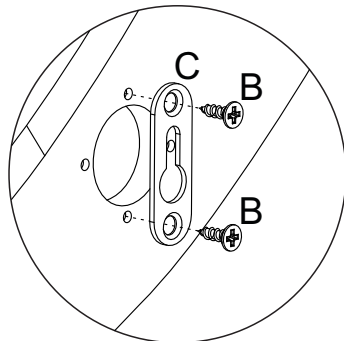
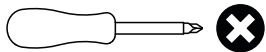

Detalhe 3
Detail/Detalle

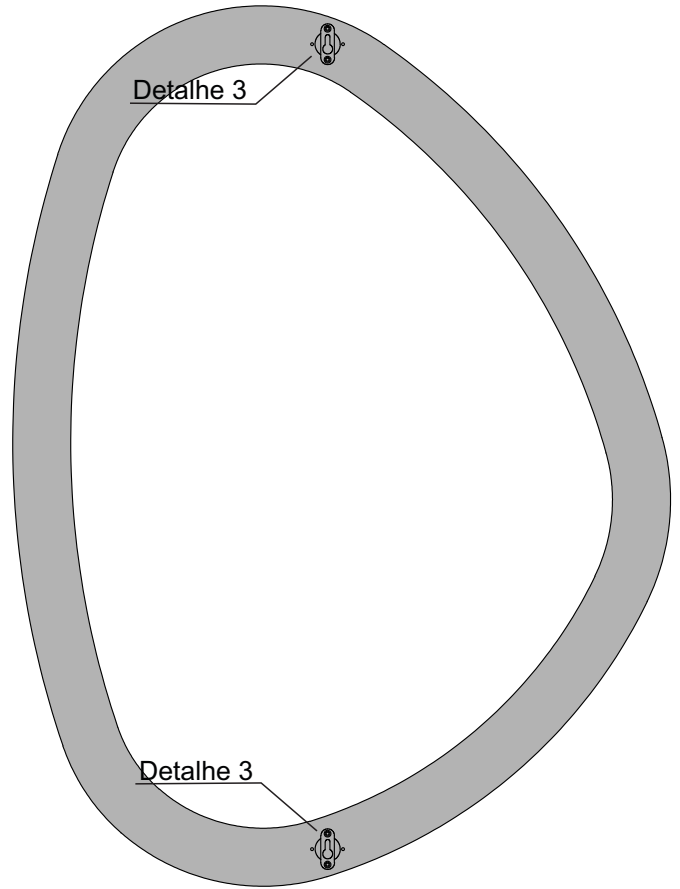

Opção D

Opciones D / Options D

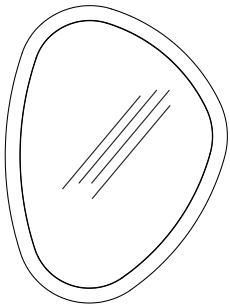

FERRAGEM
Hardware/Herraje

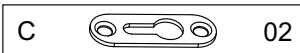
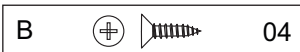

FERRAMENTA
Tool/Herramienta

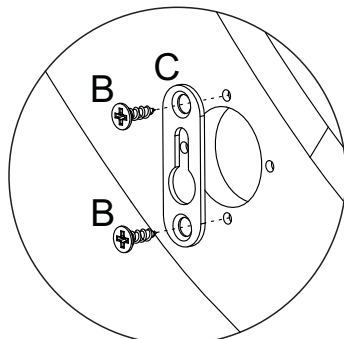
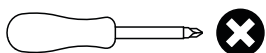

Detalhe 3
Detail/Detalle

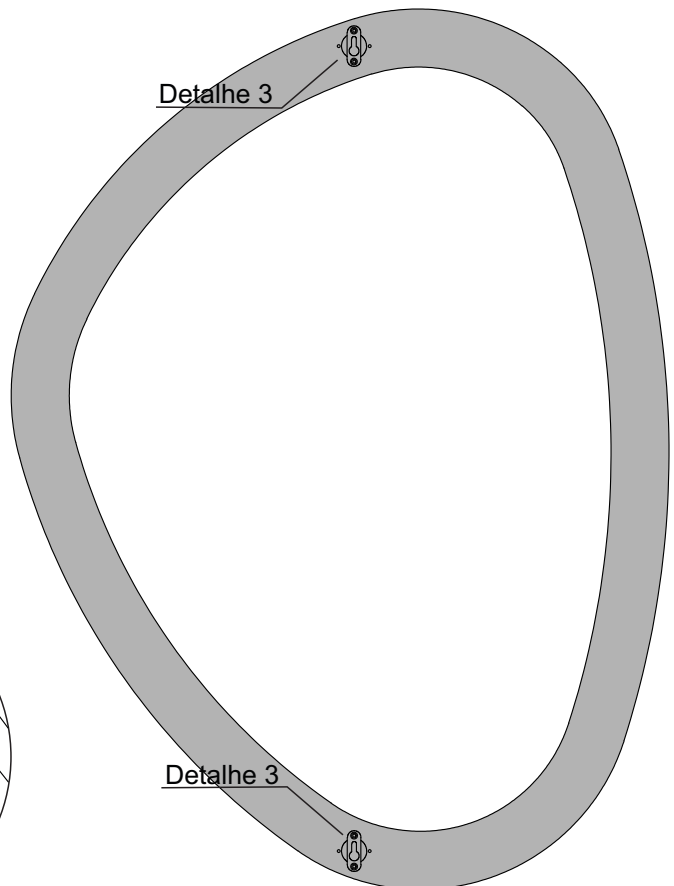

Opção A

Opciones A / Options A

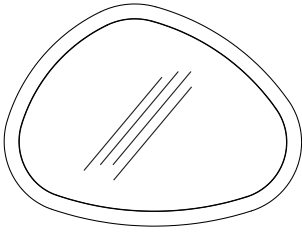

FERRAGEM
Hardware/Herraje

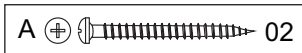

FERRAMENTA
Tool/Herramienta

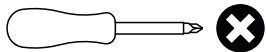

Esquema de furação da parede / Esquema de perforación de la pared / Wall drilling Scheme

-2 furos com broca Ø6mm.
-2 agujeros con taladro de 6mm.
-2 holes with 6mm drill.

PAREDE
pared
wall

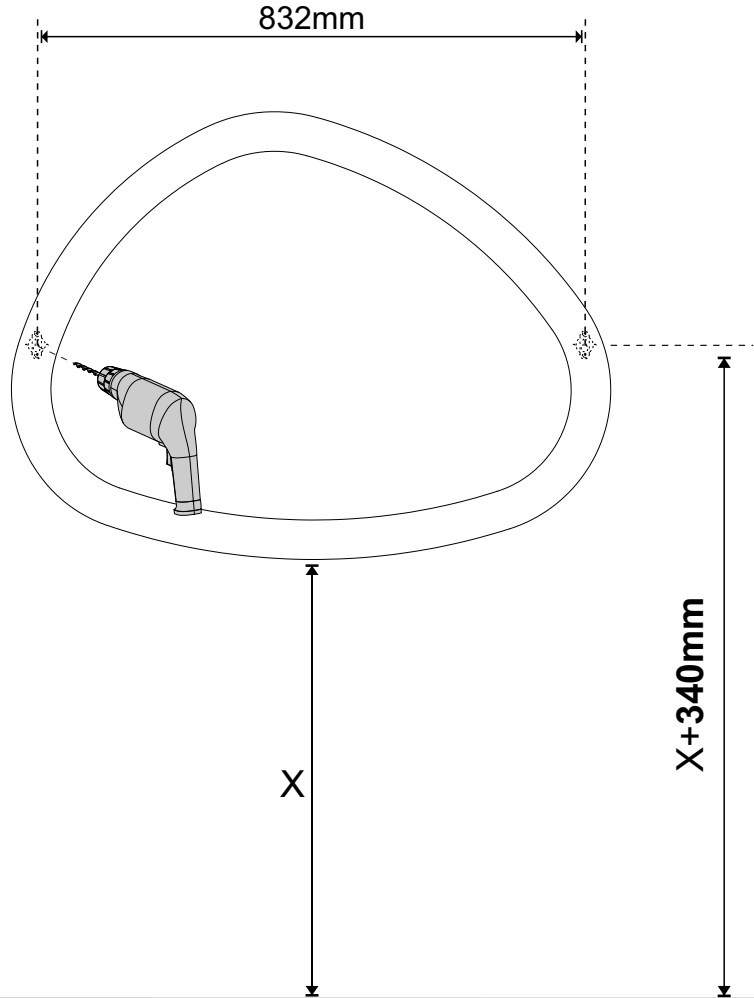

X = ALTURA QUE VOCÊ QUER DO PISO
X = Altura del piso
X = Height from the floor

PISO
piso/floor

Ex: Se você quer que o painel fique a 1200mm do piso:
Altura do furo = $1200+340=1540\text{mm}$

Ejemplo:
Si desea que el panel esté a 1200 mm del piso:
Altura del agujero = $1200+340=1540\text{mm}$

Example:
If you want the panel to be 1200mm from the floor:
Height of the hole line = $1200+340=1540\text{mm}$

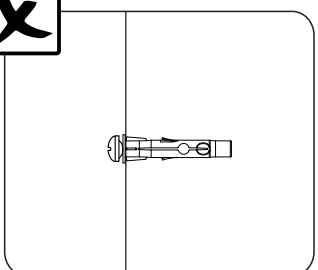
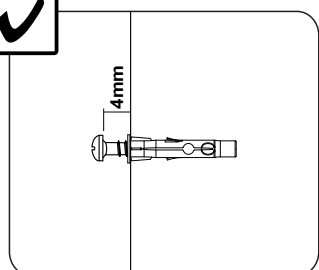
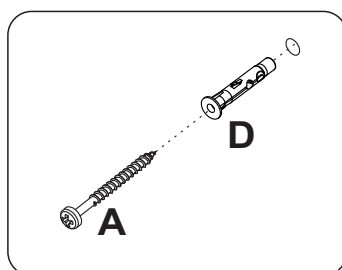
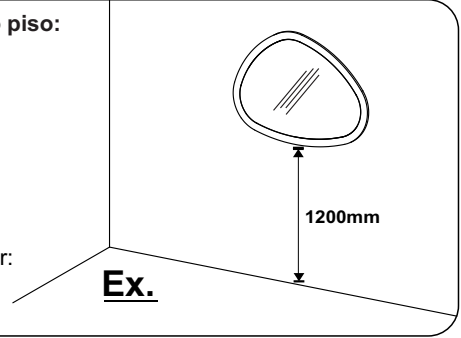

Opção B

Opciones B / Options B

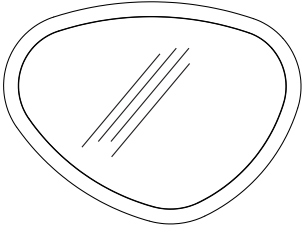

FERRAGEM
Hardware/Herraje

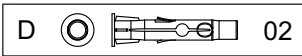

FERRAMENTA
Tool/Herramienta

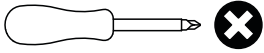

Esquema de furação da parede / Esquema de perforación de la pared / Wall drilling Scheme

-2 furos com broca Ø6mm.
-2 agujeros con taladro de 6mm.
-2 holes with 6mm drill.

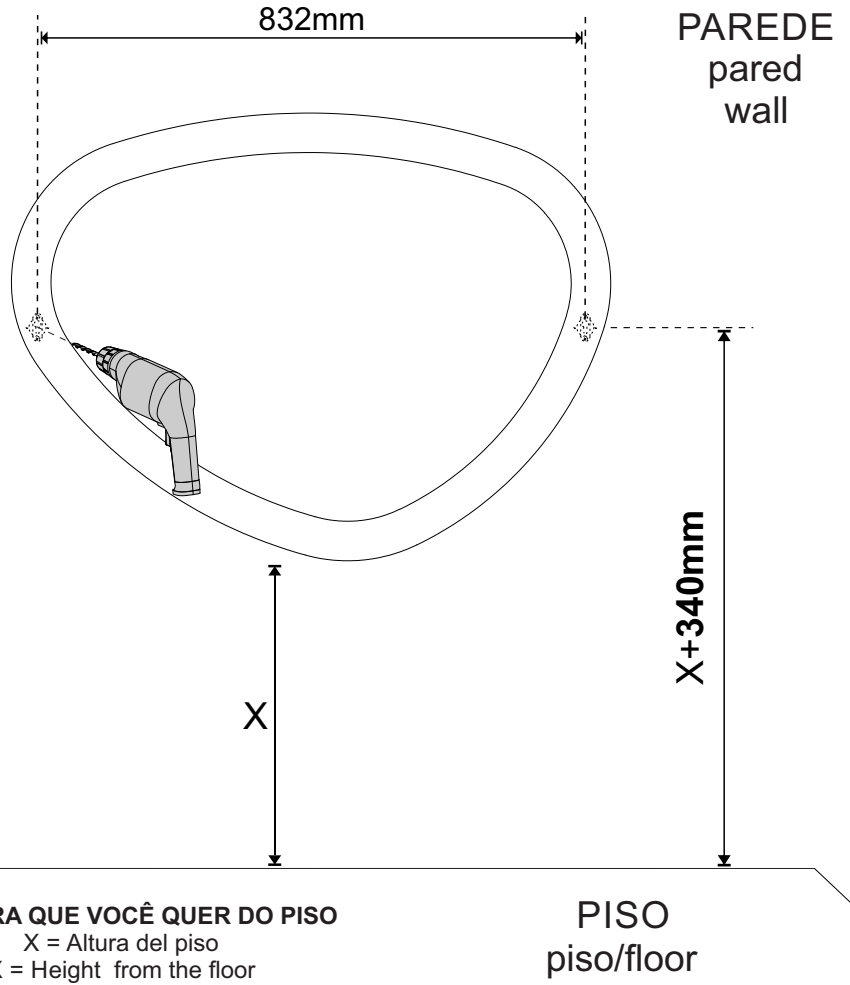

X = ALTURA QUE VOCÊ QUER DO PISO
X = Altura del piso
X = Height from the floor

PISO
piso/floor

Opção C-D

Opciones C-D / Options C-D

Opção C

Opciones C / Options C

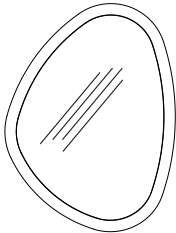

Opção D

Opciones D / Options D

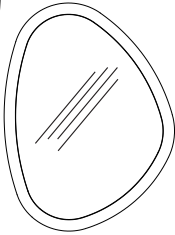

FERRAGEM
Hardware/Herraje

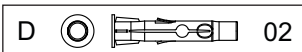
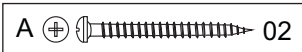

FERRAMENTA
Tool/Herramienta

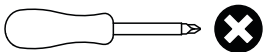

Esquema de furação da parede / Esquema de perforación de la pared / Wall drilling Scheme

-2 furos com broca Ø6mm.
-2 agujeros con taladro de 6mm.
-2 holes with 6mm drill.

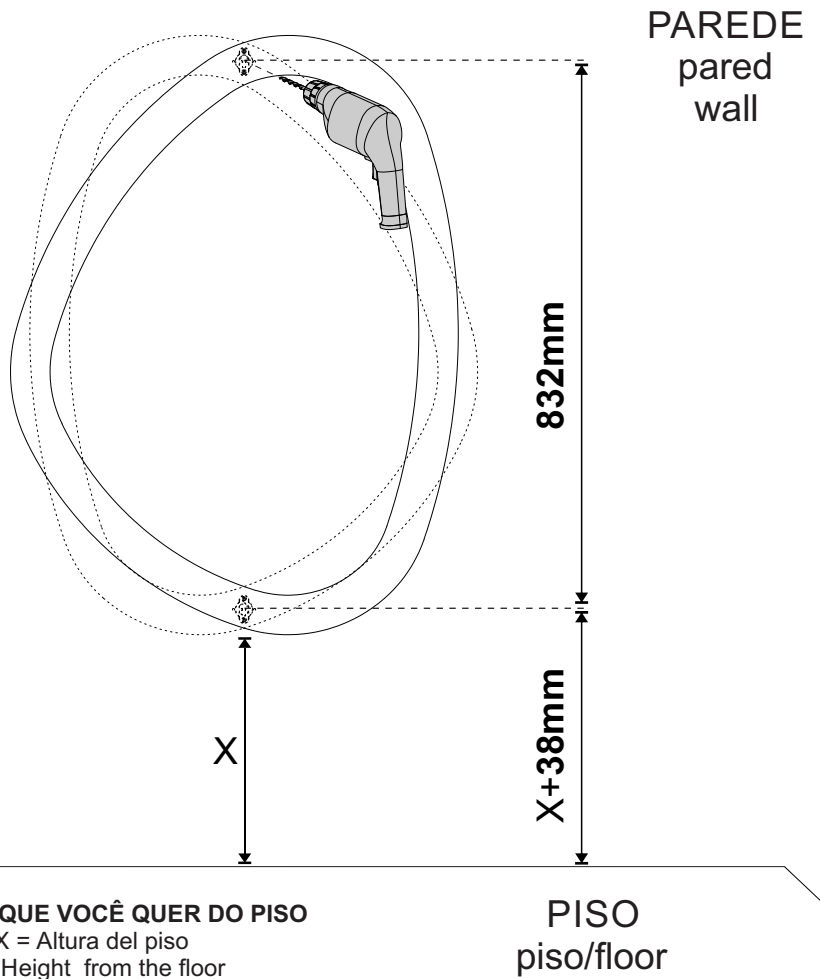

X = ALTURA QUE VOCÊ QUER DO PISO
X = Altura del piso
X = Height from the floor

PISO
piso/floor

Passo 3

Paso/Step

PEÇA
Piece/Pieza

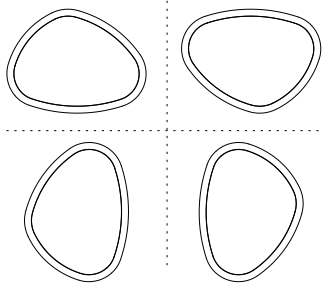

FERRAGEM
Hardware/Herraje

FERRAMENTA
Tool/Herramienta

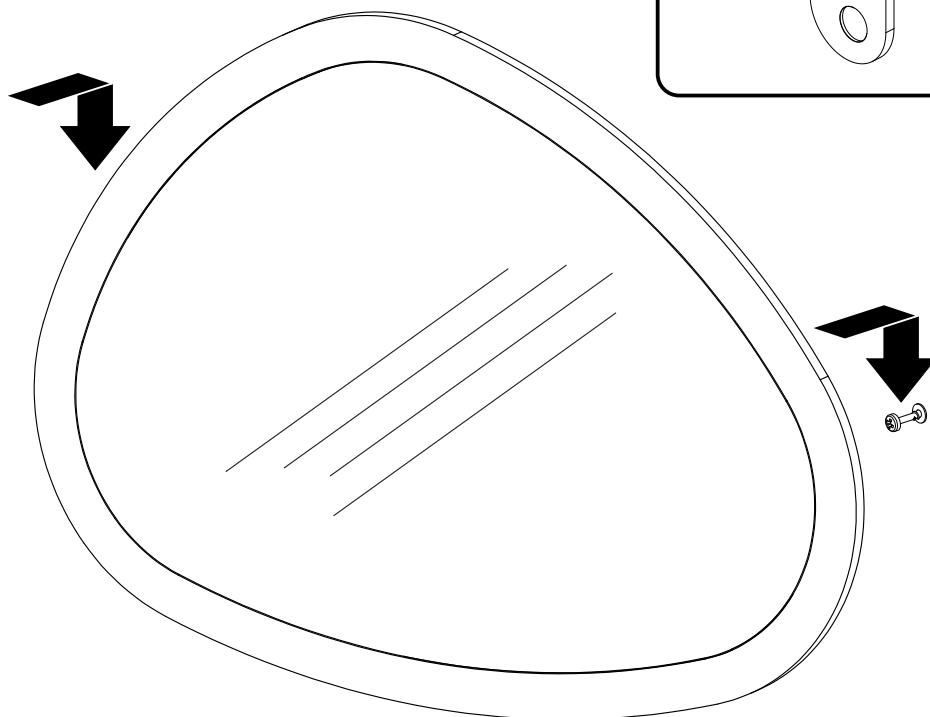
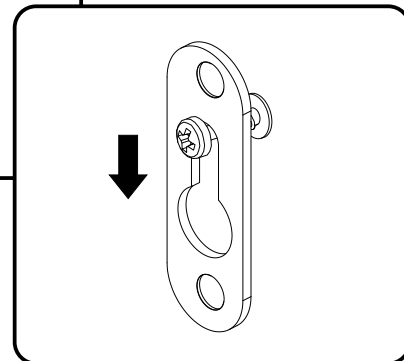
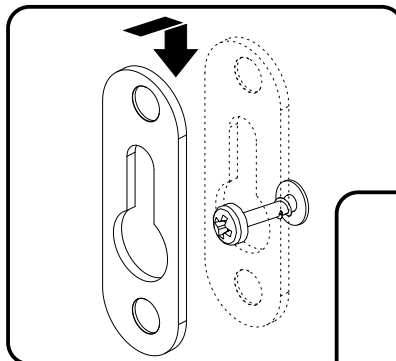

Parabéns, você montou seu móvel! Agora é só decorar sua casa e aproveitar!

Queremos ver como ficou o móvel Artely do seu jeito... Marque a gente com a #meuartely. Ficaremos felizes em compartilhar!

Ah, e se tiver qualquer dúvida, sugestão ou comentário, entra em contato com a gente pelo nosso site www.artely.com.br.

¡Congratulaciones, montaste tu mueble! ¡Ahora solo decora tu casa y disfruta!

Queremos ver este producto en tu hogar, a tu manera... Utilice #meuartely, ¡ficaremos encantados de compartir tu foto!

Si tienes alguna duda, sugerencia o comentario, contáctenos a través de nuestro sitio web www.artely.com.br.

Congratulations, you've assembled your new furniture! Decorate your home and enjoy!

We want to see how this product is in your home... Use #meuartely, we will be happy to share your picture!

If you have any doubt, suggestion or comment, get in touch with us through our website www.artely.com.br.

