

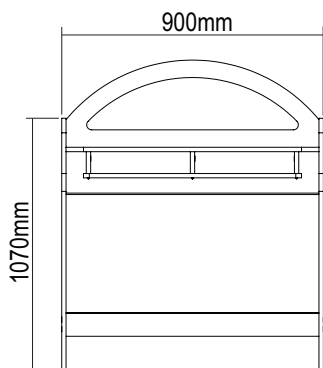

# Escrivaninha Ceci

Escrivaninha Ceci / Escrivaninha Ceci

Versão 1.0 / Versión 1.0 / 1.0 Version

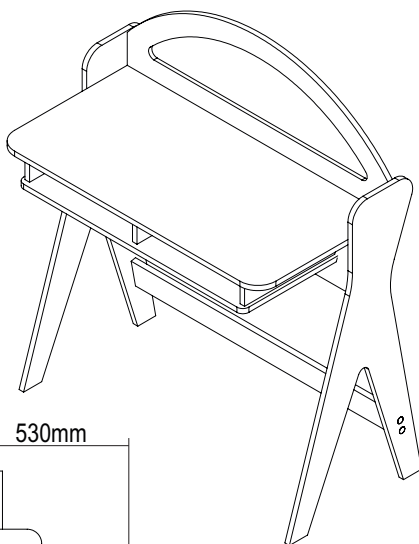

frente/frente/front

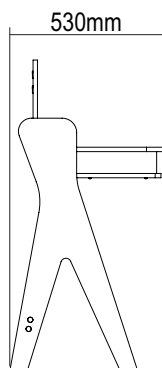

lateral/lado/side

## Conservação e Limpeza - Conservación y Limpieza - Conservation and Cleaning

**Não expor o produto ao sol, altas temperaturas e umidade. Não arrastar objetos sobre a superfície do móvel (ex.: TV, equipamentos eletrônicos, objetos decorativos...). Manter em local seco e arejado. Para a limpeza, utilizar um pano seco e macio. Não é necessário o uso de materiais abrasivos ou álcool.**

*No exponga el producto a la luz solar, las altas temperaturas y la humedad. No arrastre los objetos en la superficie de la unidad (por ejemplo, TV, equipos electrónicos, objetos de decoración ...). Mantener en un lugar fresco y seco. Para la limpieza, utilizar un paño seco y suave. El uso de materiales abrasivos o del alcohol no es necesario.*

*Do not expose the product to sunlight, high temperatures and humidity. Do not drag objects across the surface of the unit (TV, electronic equipments, decorative objects ...). Keep it in a cool and dry place. For cleaning, use a dry and soft cloth. Do not use abrasive materials or alcohol.*

### Garantia

*Este certificado de Garantia é uma vantagem adicional oferecida ao consumidor, porém para que o mesmo tenha validade é imprescindível que seja apresentada a NOTA FISCAL de compra do produto.*

*Com este produto, a Artely tem como objetivo atender plenamente o proprietário-consumidor, proporcionando a garantia na forma aqui estabelecida, pelo período de três meses a partir da data da nota fiscal de compra. A Artely restringe a sua responsabilidade à substituição gratuita das peças defeituosas, em caso de defeitos ou avarias devidamente constatados como sendo de fabricação, durante a vigência desta garantia.*

*A Artely declara a garantia nula e sem efeito se o produto for alterado, adulterado, molhado ou consertado e ainda pela prática de montagem inadequada ou mau uso. Também será considerada nula em casos de força maior, como aqueles causados por agentes da Natureza (chuvas, incêndios, excesso de umidade, cupins,...) e eventos externos como objetos arrastados sobre a superfície do móvel (ex.: TV, DVD, aparelho de som, objetos decorativos...).*

*Para exercer seus direitos de comprador é importante que antes de montar seu produto você leia com atenção as instruções de cada passo do manual de montagem que acompanha o móvel.*

*Caso o produto não esteja em conformidade, entre em contato com a loja onde efetuou a compra e faça sua reclamação, apontando os defeitos técnicos observados. Para agilizar o seu atendimento, tenha sempre em mãos o manual de montagem com os respectivos números das peças defeituosas, conforme descritas no manual.*

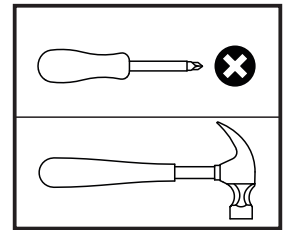
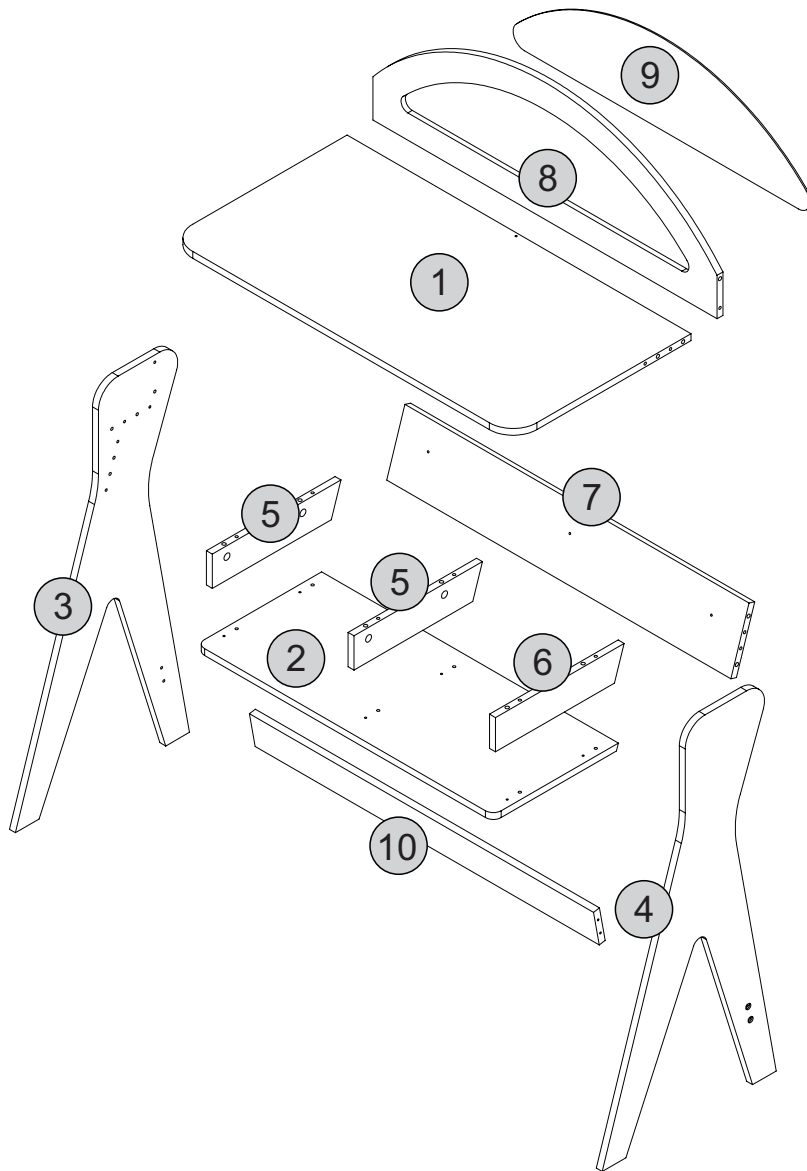







| Descrição                         | Descripción          | Description        | Qty |
|-----------------------------------|----------------------|--------------------|-----|
| 1-Tampo (870x450x15mm)            | 1-Tapa               | 1-Top              | 1   |
| 2-Base (450x316x15mm)             | 2-Base               | 2-Base             | 1   |
| 3-Lateral Esquerda (870x440x15mm) | 3-Lado Izquierdo     | 3-Left Side        | 1   |
| 4-Lateral Direita (870x440x15mm)  | 4-Lado Derecho       | 4-Right Side       | 1   |
| 5-Divisão Esquerda (325x75x15mm)  | 5-División Izquierdo | 5-Left Division    | 2   |
| 6-Divisão Direita (325x75x15mm)   | 6-División Derecho   | 6-Right Division   | 1   |
| 7-Travessa Frontal (870x150x15mm) | 7-Travesaño Frontal  | 7-Front Crosspiece | 1   |
| 8-Traseira (870x300x15mm)         | 8-Trasero            | 8-Back             | 1   |
| 9-Almofada (750x202x3mm)          | 9-Almohada           | 9-Pillow           | 1   |
| 10-Travessa (870x80x15mm)         | 10-Travesaño         | 10-Crosspiece      | 1   |

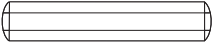
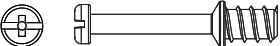

- O número na borda da peça corresponde ao manual.  
 - Para retirada do número usar Lustra-Móveis, Álcool em Gel ou Borracha.  
 -El número en el borde de la pieza coincide con el manual.  
 -Use una goma de borrar blanca, alcohol en gel o lustrador para muebles para eliminar los números.  
 -The number on the edge of the piece matches the manual.  
 -Use a White eraser, Alcohol Gel or Furniture Polish to remove the numbers.

# Lista de Materiais

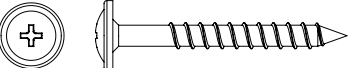
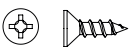
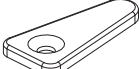
## Lista de Materiales/ Hardware List

|          |   |  |           |
|----------|---|--|-----------|
| <b>A</b> |    | Cavilha / Tarugo / Dowel<br>Ø6x30mm                | <b>22</b> |
| <b>B</b> |    | Minifix / Minifix / Minifix<br>Ø7x30mm             | <b>16</b> |
| <b>C</b> |    | Tambor / Tambor / Minifix Cam<br>Ø15x12mm          | <b>16</b> |
| <b>D</b> |    | Tapa furo adesivo / Adhesivo / Hole Cover<br>Ø18mm | <b>19</b> |
| <b>E</b> |    | Parafuso<br>Tornillo / Screw<br>Ø3,5x40mm          | <b>10</b> |
| <b>F</b> |    | Parafuso<br>Tornillo / Screw<br>Ø5,0x40mm          | <b>04</b> |
| <b>G</b> |    | Parafuso<br>Tornillo / Screw<br>Ø3,5x12mm          | <b>08</b> |
| <b>H</b> |  | Tramela/<br>Trampa / Fastener<br>25x12<br>Plástico | <b>08</b> |
| <b>I</b> |  | Sapata Fixa / Pata Fija / Fixed Foot<br>Ø5x10mm    | <b>04</b> |

### DICAS PARA FIXAR MINIFIX

TIP TO FASTEN THE MINIFIX  
PISTA PARA ARREGLAR EL MINIFIX

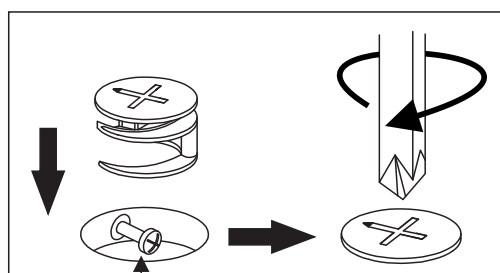

**Cabeça do parafuso precisa estar no centro**  
La cabeza del tornillo debe estar en el centro  
Screw head has to be in the center

#### Parafuso Minifix

Tornillo minifix/Minifix screw

**Fixe o parafuso até o ressalto encostar na superfície da peça (veja o exemplo abaixo).**

Tighten the screw until its overhang part lean on the piece surface (see the example below).

Fije el tornillo hasta que su parte sobresaliente toque la superficie de la pieza (vea el ejemplo abajo).

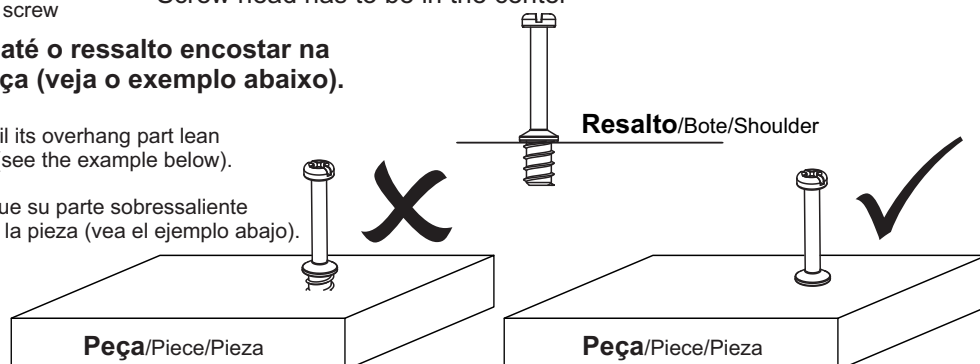

# Passo 1

Paso/Step

**PEÇA**  
Piece/Pieza

1 - TAMPO x1

**FERRAGEM**  
Hardware/Herraje

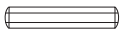
A  04

B  06

**FERRAMENTA**  
Tool/Herramienta

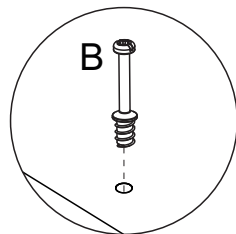
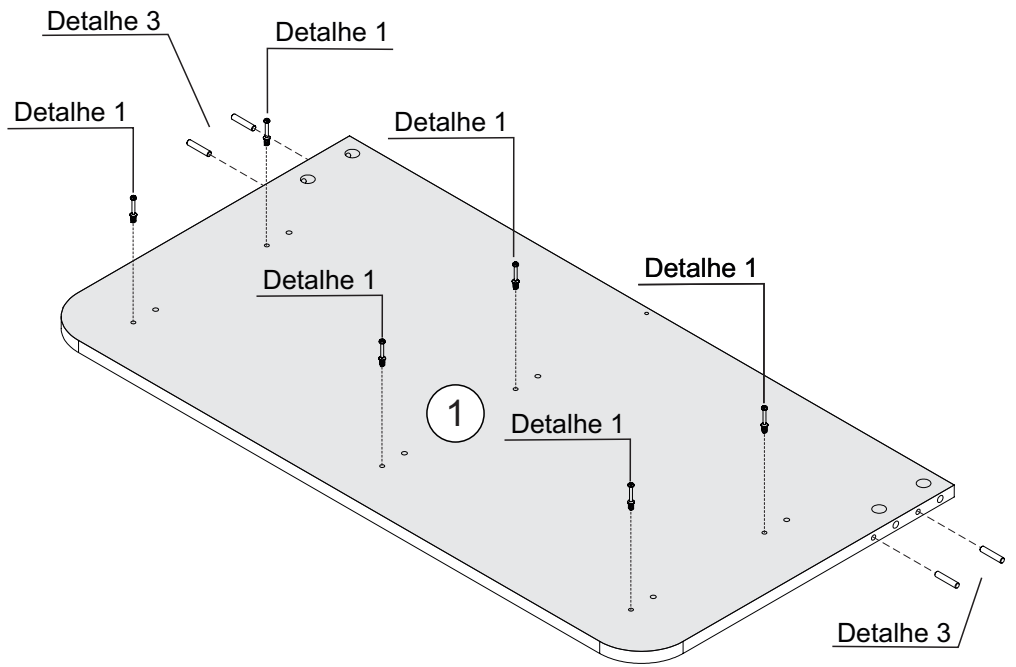
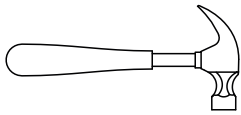
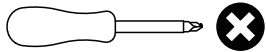

**Detalhe 1**  
Detail/Detalle

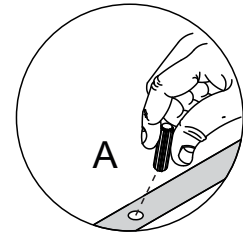
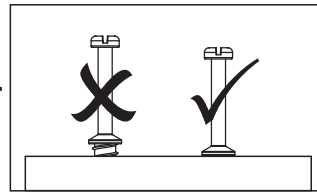

**Detalhe 2**  
Detail/Detalle

# Passo 2

Paso/Step

**PEÇA**  
Piece/Pieza

3 - LATERAL ESQUERDA x1

**FERRAGEM**  
Hardware/Herraje

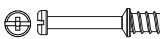
B  05

I  02

**FERRAMENTA**  
Tool/Herramienta

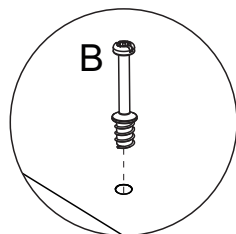
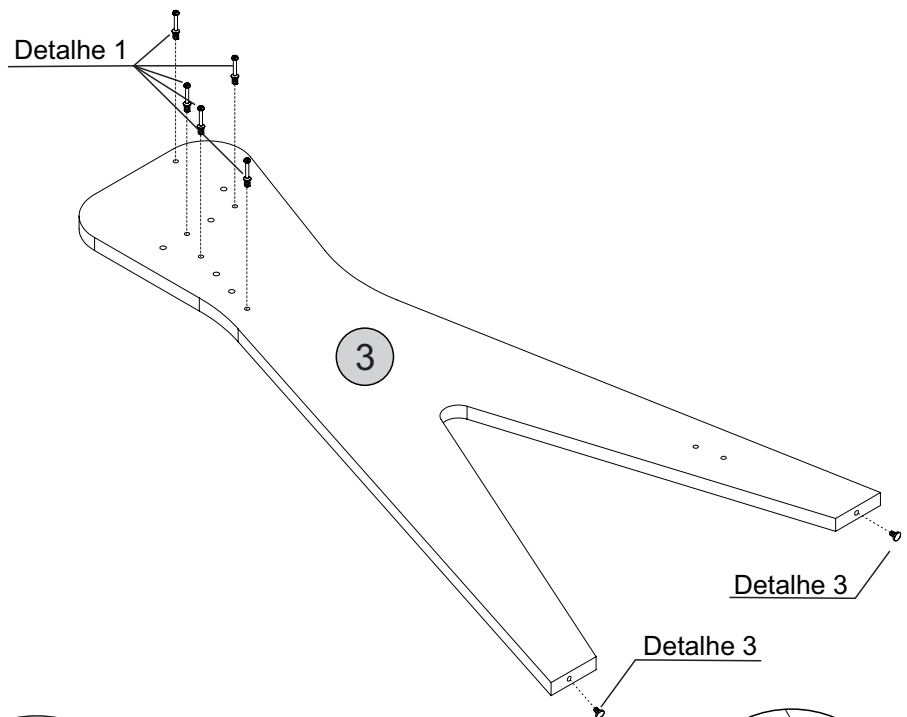
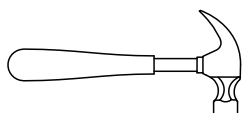
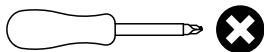

**Detalhe 1**  
Detail/Detalle

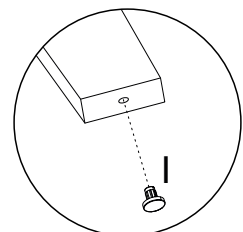
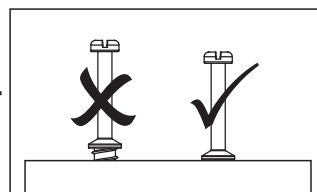

**Detalhe 3**  
Detail/Detalle

# Passo 3

Paso/Step

**PEÇA**  
Piece/Pieza

4 - LATERAL DIREITA x1

**FERRAGEM**  
Hardware/Herraje

B  05

I  02

**FERRAMENTA**  
Tool/Herramienta

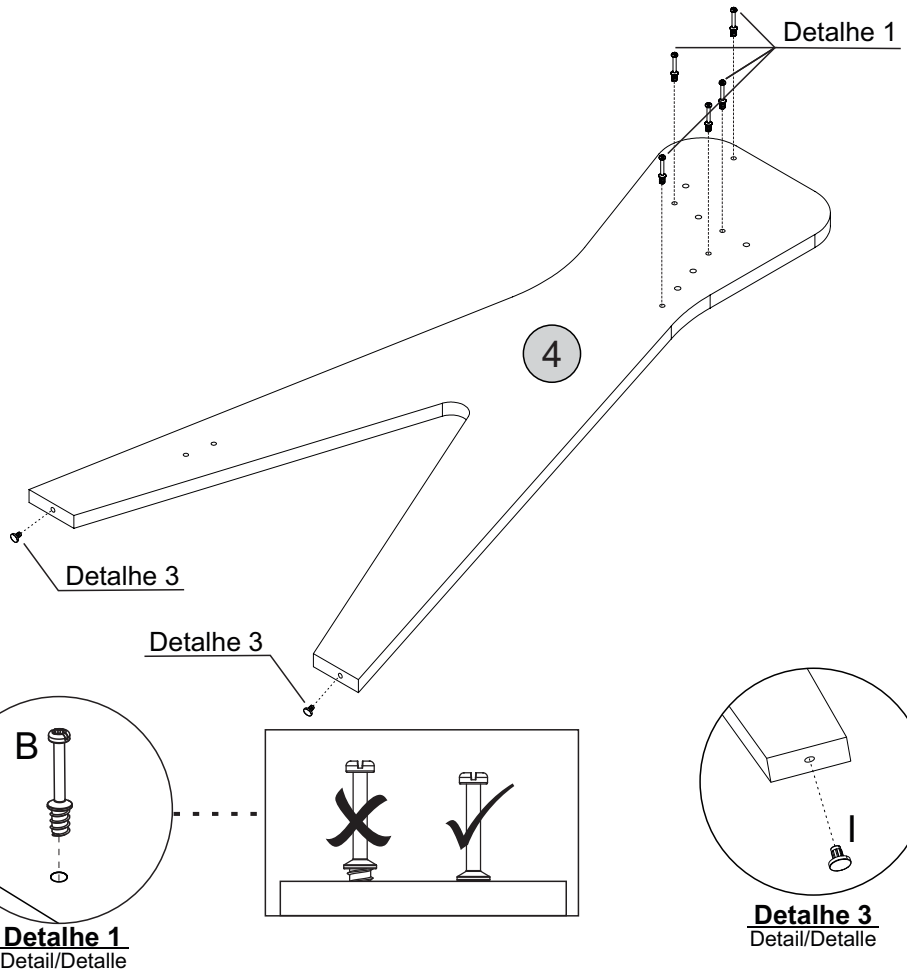
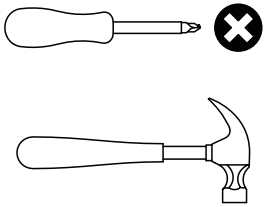

# Passo 4

Paso/Step

**PEÇA**  
Piece/Pieza

7 - TRAVESSA FRONTAL x1

**FERRAGEM**  
Hardware/Herraje

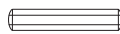
A  04

**FERRAMENTA**  
Tool/Herramienta

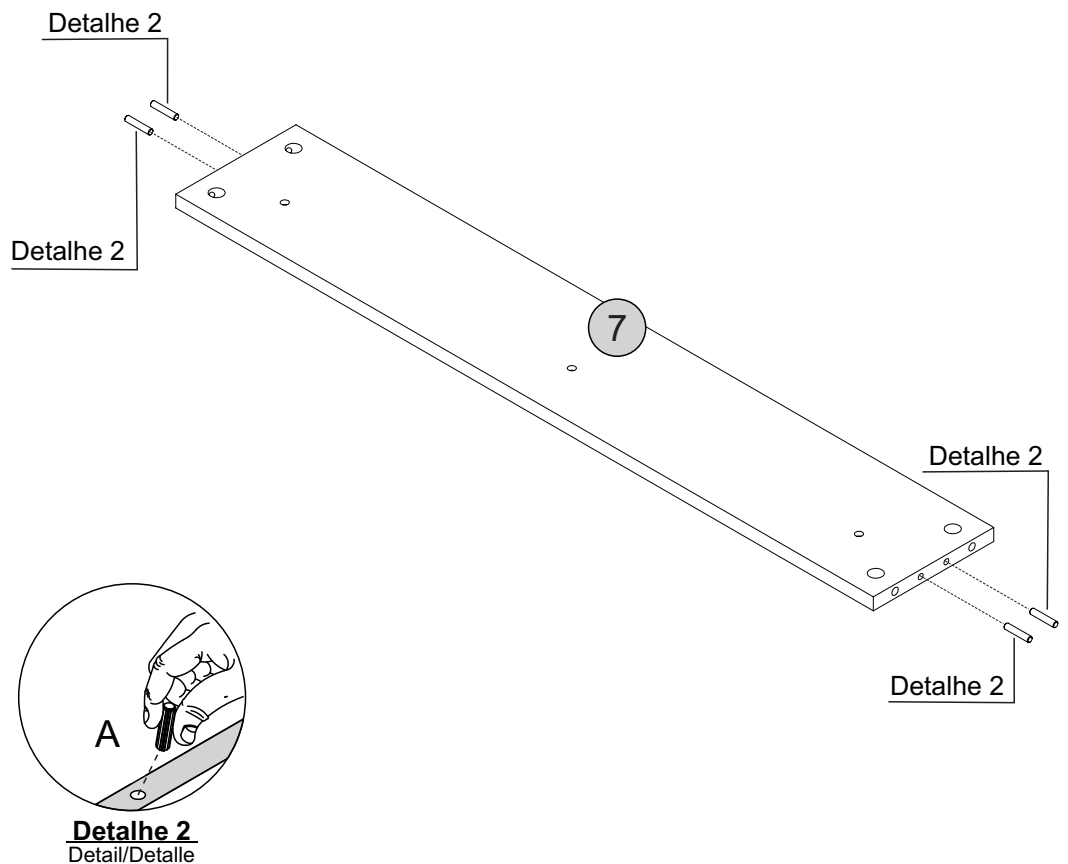
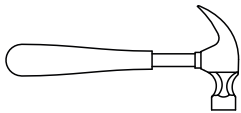

# Passo 5

Paso/Step

**PEÇA**  
Piece/Pieza

8 - TRASEIRA x1

**FERRAGEM**  
Hardware/Herraje

A  02

**FERRAMENTA**  
Tool/Herramienta

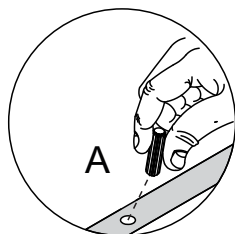
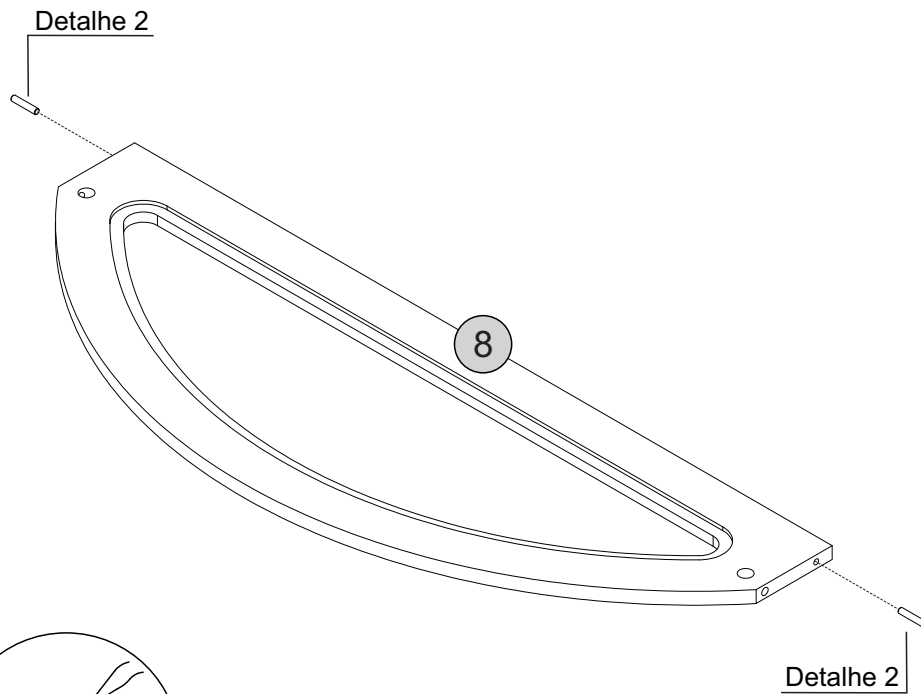
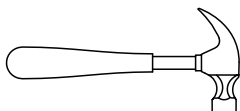

**Detalhe 2**  
Detail/Detalle

# Passo 6

Paso/Step

**PEÇA**  
Piece/Pieza

08 - TRASEIRA x1

09 - ALMOFADA x1

**FERRAGEM**  
Hardware/Herraje

G  08

H  08

**FERRAMENTA**  
Tool/Herramienta

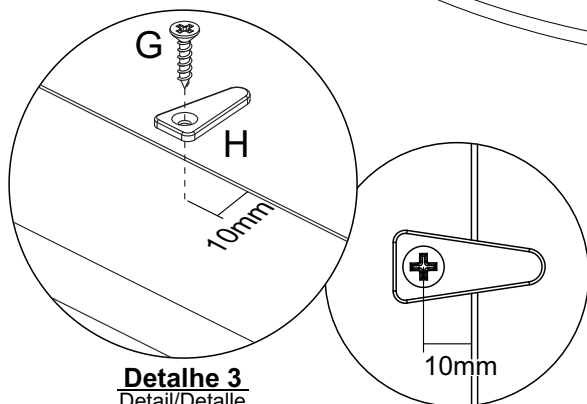
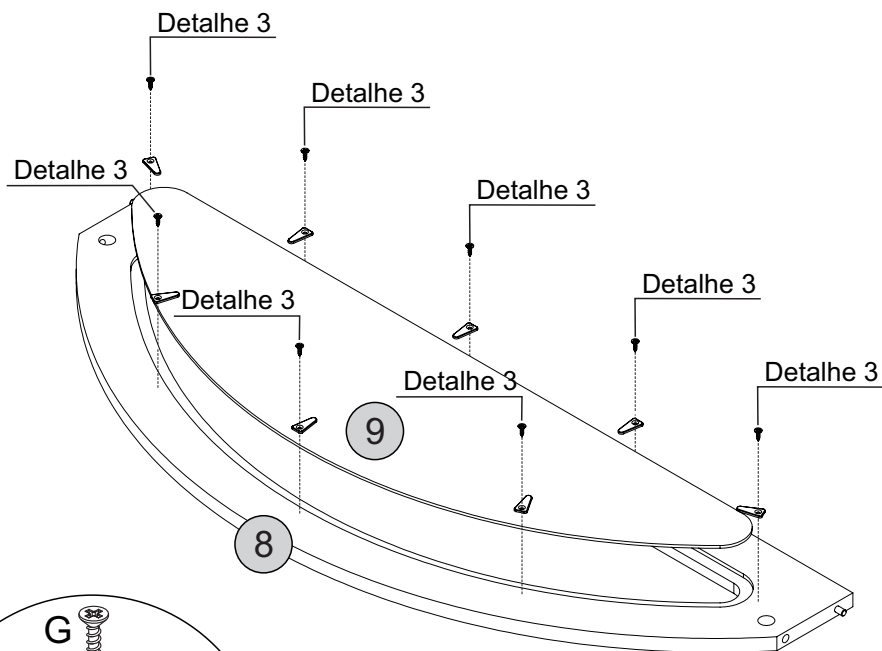
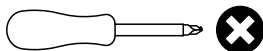

**Detalhe 3**  
Detail/Detalle

# Passo 7

Paso/Step

**PEÇA**  
Piece/Pieza

5 - DIVISÃO ESQUERDA x2

**FERRAGEM**  
Hardware/Herraje

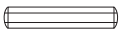
A  08

**FERRAMENTA**  
Tool/Herramienta

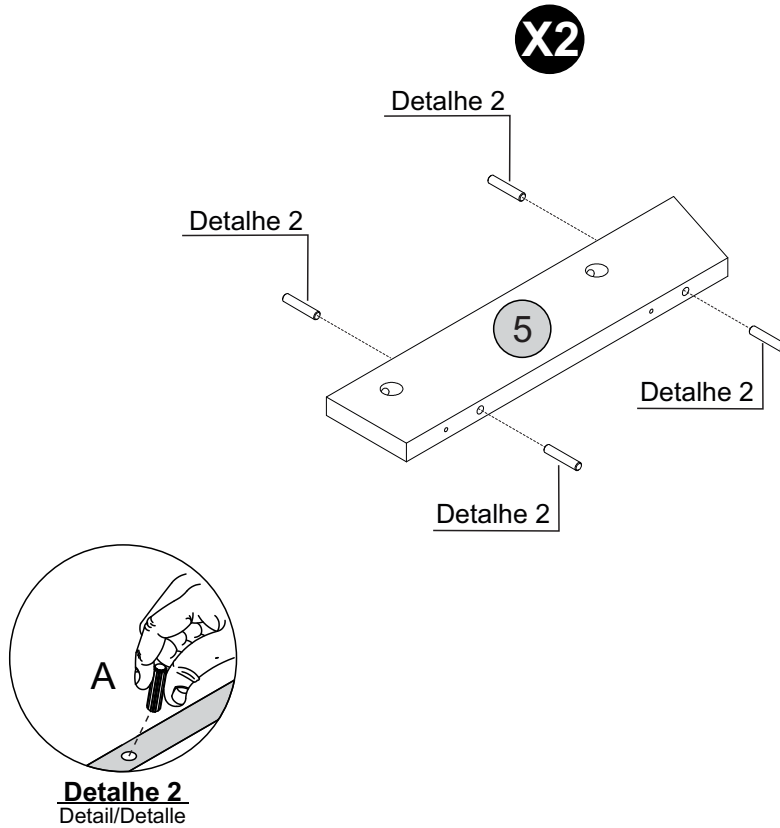
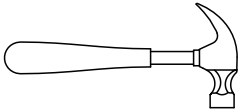

# Passo 8

Paso/Step

**PEÇA**  
Piece/Pieza

6 - DIVISÃO DIREITA x1

**FERRAGEM**  
Hardware/Herraje

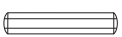
A  04

**FERRAMENTA**  
Tool/Herramienta

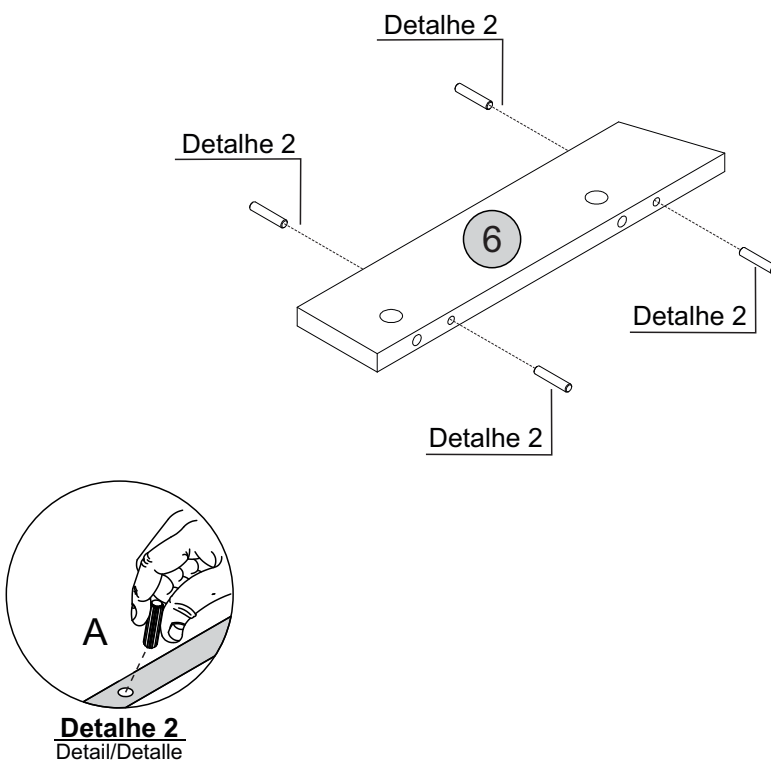
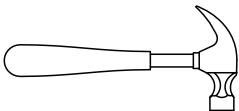



# Passo 09

Paso/Step

## PEÇA Piece/Pieza

- 1 - TAMPO x1
- 5 - DIVISÃO ESQUERDA x2
- 6 - DIVISÃO DIREITA x1

## FERRAGEM Hardware/Herraje

- C   06
- D  06

## FERRAMENTA Tool/Herramienta

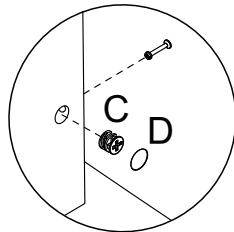
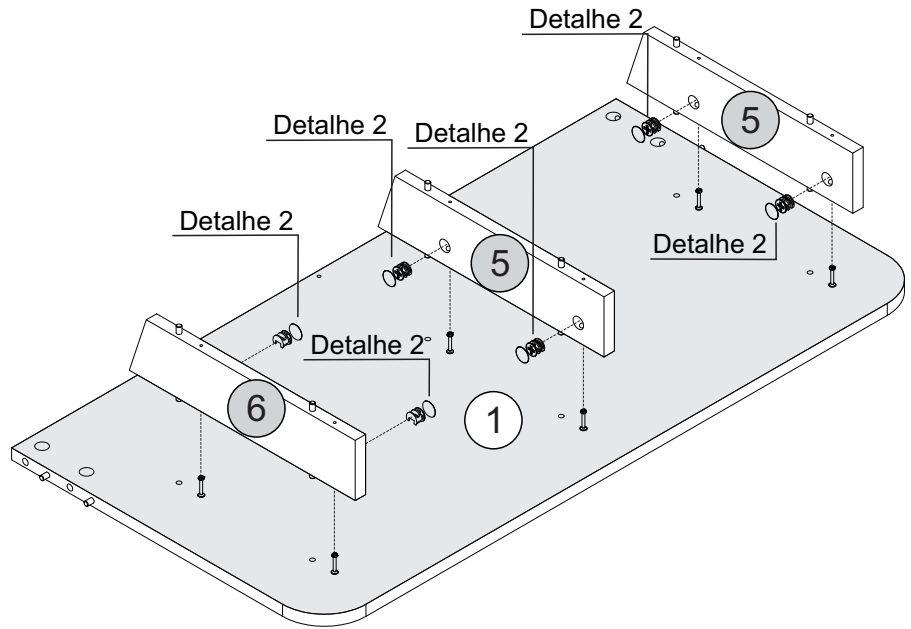
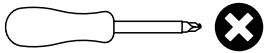

**Detalhe 4**  
Detalle/Detail

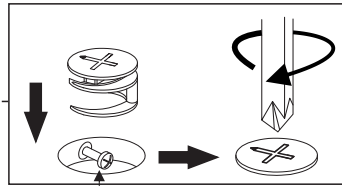

**Cabeça do parafuso precisa estar no centro**  
La cabeza del tornillo debe estar en el centro  
Screw head has to be in the center

# Passo 10

Paso/Step

## PEÇA Piece/Pieza

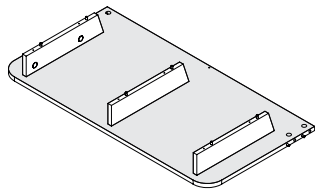

- 2 - BASE x1

## FERRAGEM Hardware/Herraje

- E   06

## FERRAMENTA Tool/Herramienta

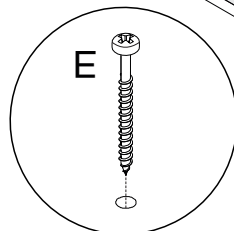
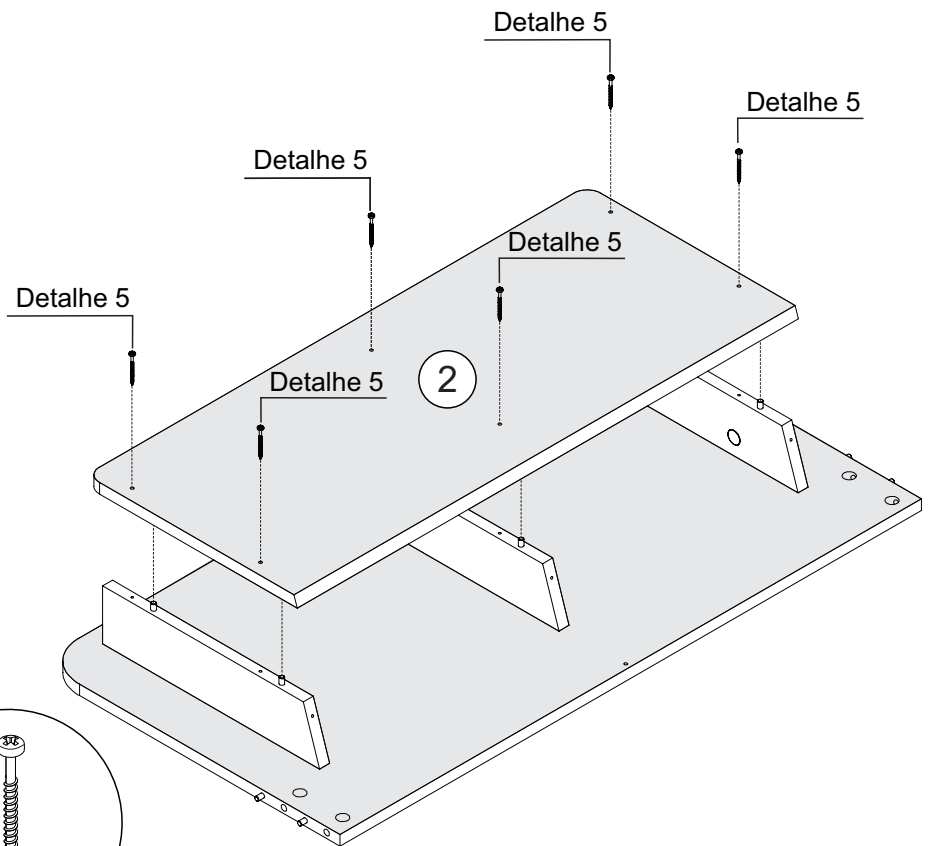
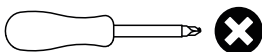

**Detalhe 5**  
Detalle/Detail



# Passo 11

Paso/Step

**PEÇA**  
Piece/Pieza

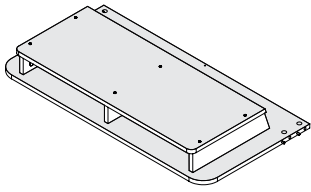

7 - TRASEIRO x1

**FERRAGEM**  
Hardware/Herraje

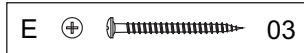

**FERRAMENTA**  
Tool/Herramienta

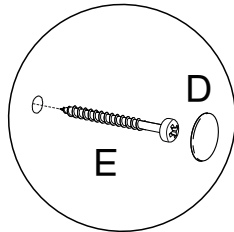
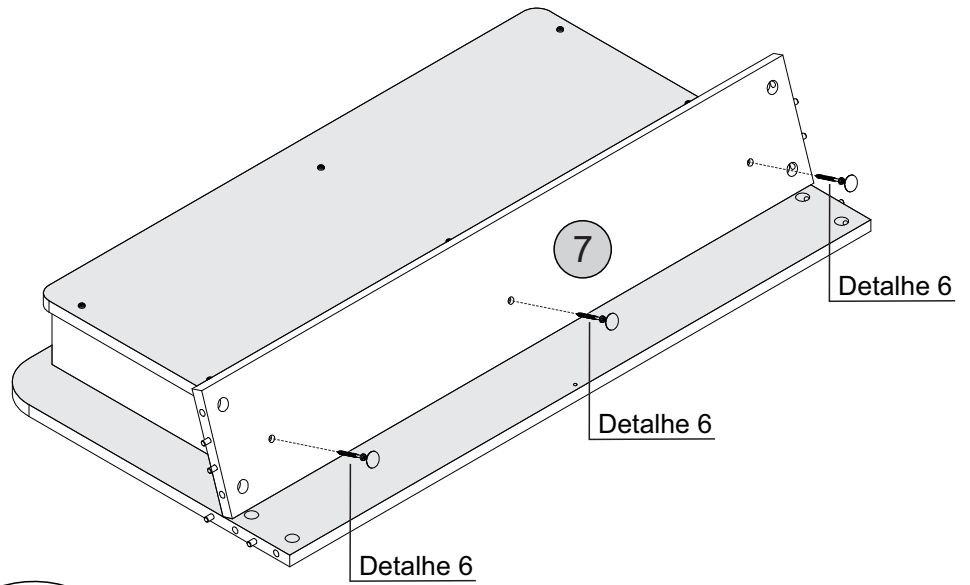
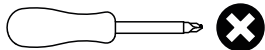

**Detalhe 6**  
Detalle/Detail

# Passo 12

Paso/Step

**PEÇA**  
Piece/Pieza

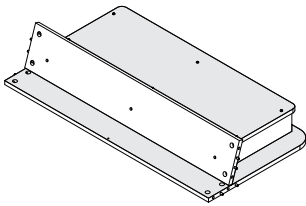

3 - LATERAL ESQUERDA x1

**FERRAGEM**  
Hardware/Herraje

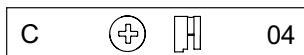

**FERRAMENTA**  
Tool/Herramienta

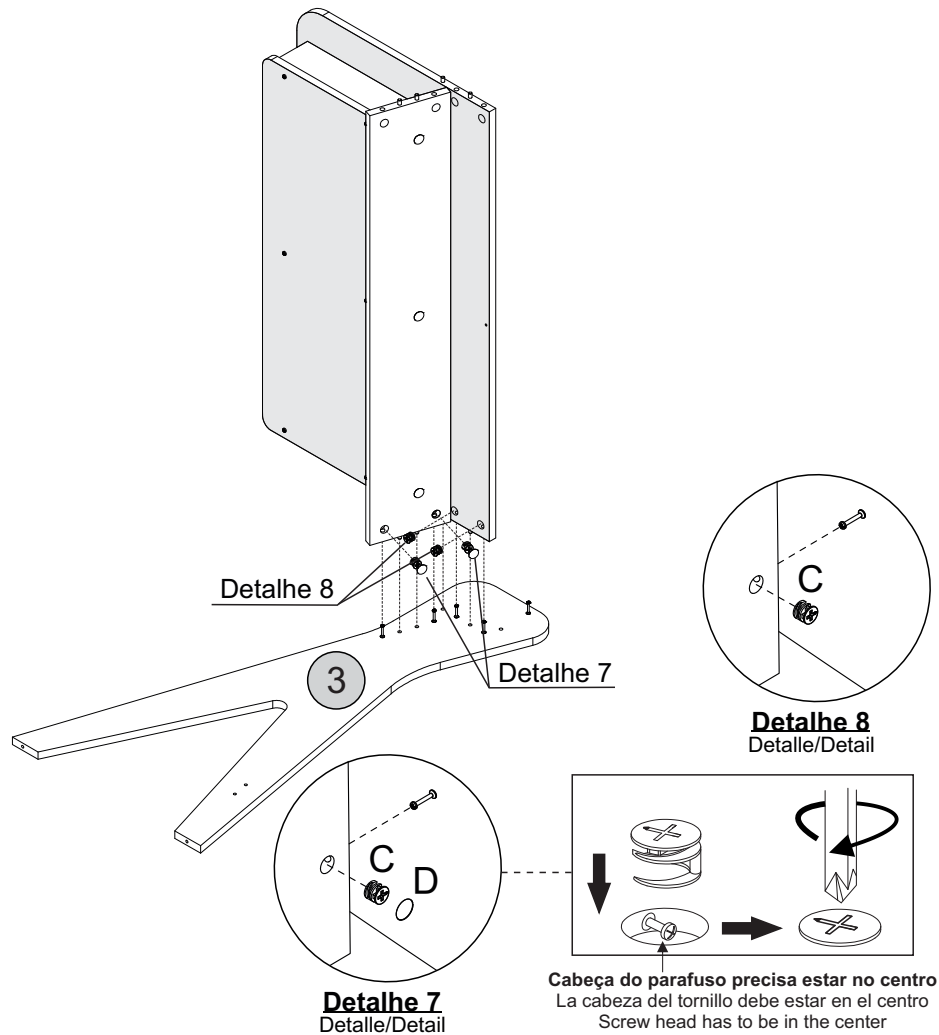
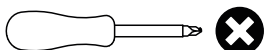

**Detalhe 7**  
Detalle/Detail

**Detalhe 8**  
Detalle/Detail

**Cabeça do parafuso precisa estar no centro**  
La cabeza del tornillo debe estar en el centro  
Screw head has to be in the center

# Passo 13

Paso/Step

**PEÇA**  
Piece/Pieza

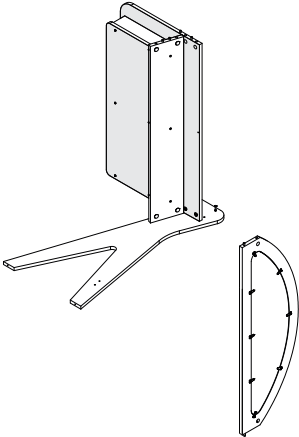

**FERRAGEM**  
Hardware/Herraje



**FERRAMENTA**  
Tool/Herramienta

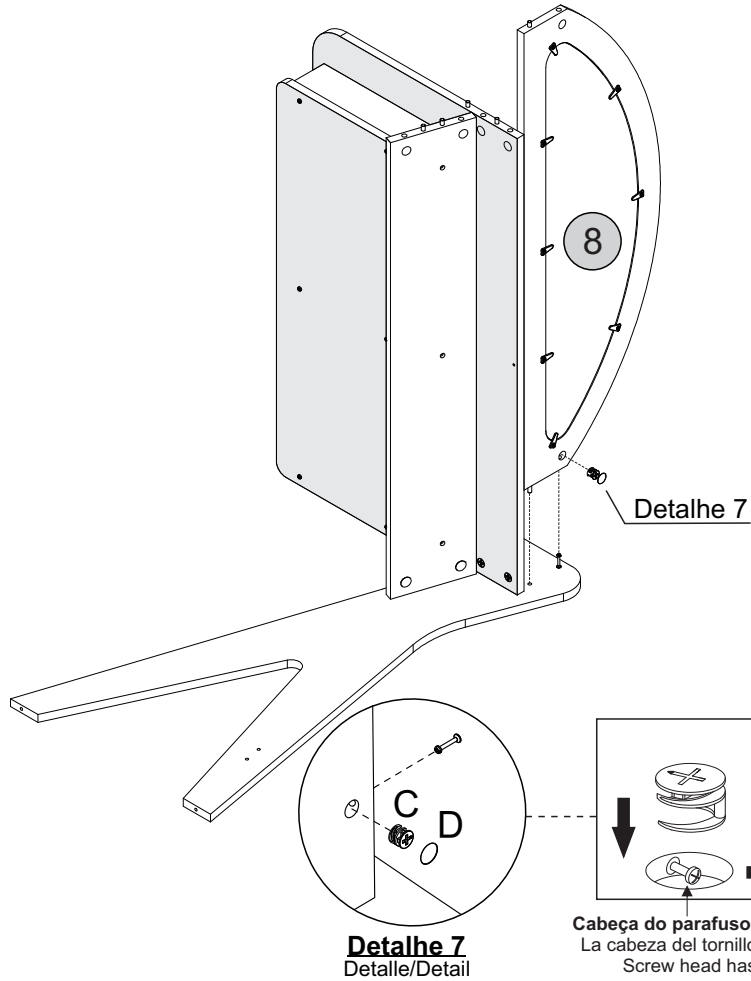
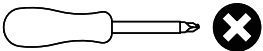

# Passo 14

Paso/Step

**PEÇA**  
Piece/Pieza

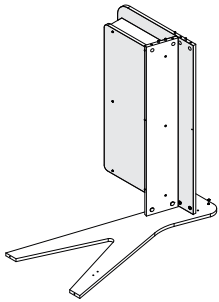

4 - LATERAL DIREITA x1

**FERRAGEM**  
Hardware/Herraje

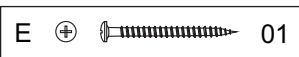
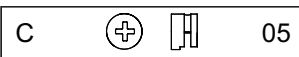

**FERRAMENTA**  
Tool/Herramienta

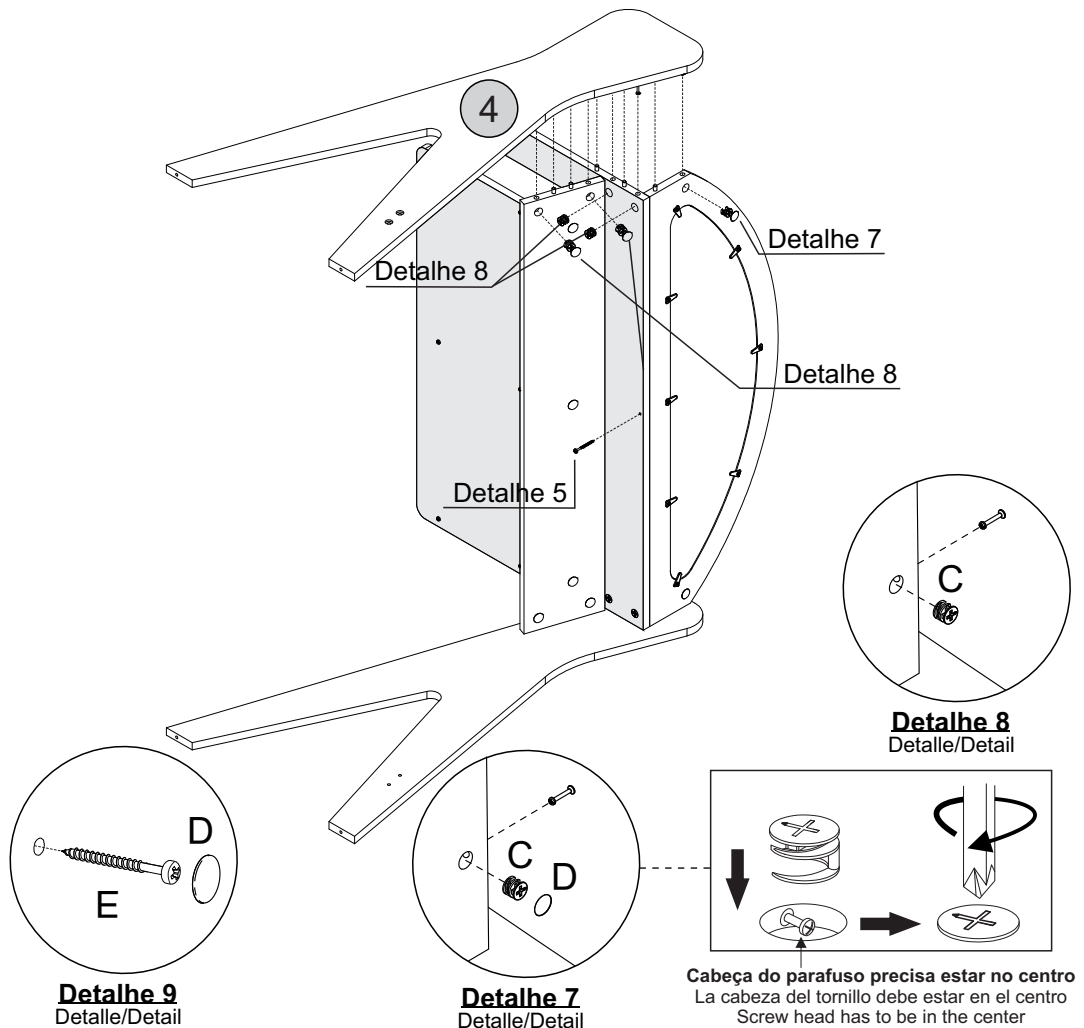
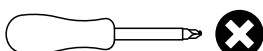

# Passo 15

Paso/Step

**PEÇA**  
Pieça/Pieza

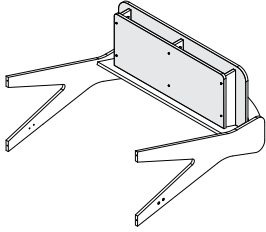

10 - TRAVESSA x1

**FERRAGEM**  
Hardware/Herraje

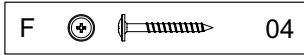

**FERRAMENTA**  
Tool/Herramienta

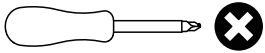

Detalhe 10

Detalhe 10

10

Detalhe 10

Detalhe 10

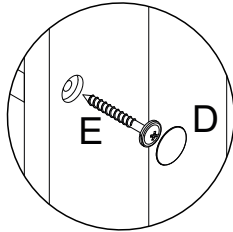

**Detalhe 10**  
Detail/Detalle

# Passo 16

Paso/Step

**PEÇA**  
Pieça/Pieza

**FERRAGEM**  
Herraje/Hardware

**FERRAMENTA**  
Herramienta/Tool

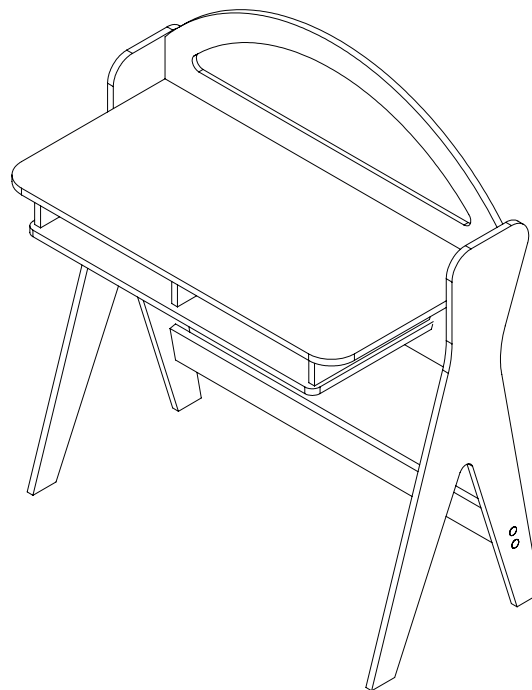

**Parabéns, você montou seu móvel! Agora é só decorar sua casa e aproveitar!**

**Queremos ver como ficou o móvel Artely do seu jeito... Marque a gente com a #meuartely. Ficaremos felizes em compartilhar!**

**Ah, e se tiver qualquer dúvida, sugestão ou comentário, entra em contato com a gente pelo nosso site [www.artely.com.br](http://www.artely.com.br).**

¡Congratulaciones, montaste tu mueble! ¡Ahora solo decora tu casa y disfruta!

Queremos ver este producto en tu hogar, a tu manera... Utilice #meuartely, ¡ficaremos encantados de compartir tu foto!

Si tienes alguna duda, sugerencia o comentario, contáctenos a través de nuestro sitio web [www.artely.com.br](http://www.artely.com.br).

Congratulations, you've assembled your new furniture! Decorate your home and enjoy!

We want to see how this product is in your home... Use #meuartely, we will be happy to share your picture!

If you have any doubt, suggestion or comment, get in touch with us through our website [www.artely.com.br](http://www.artely.com.br).