

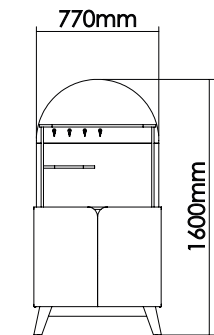

Cantinho Café Viena

Aparador de café Viena / Vienna coffee sideboard
Versão 1.0 / Versión 1.0 / Version 1.0

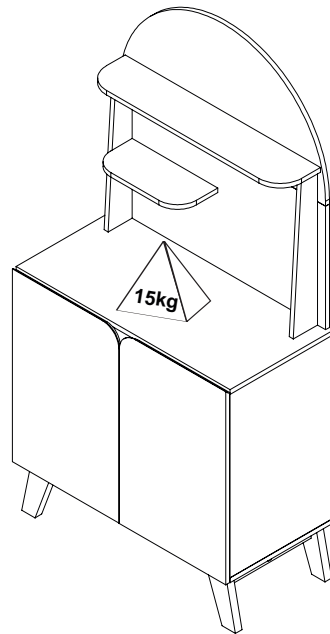

frente/frente/front

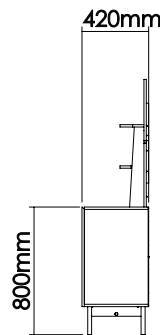

lateral/lado/side

Conservação e Limpeza - Conservación y Limpieza - Conservation and Cleaning

Não expor o produto ao sol, altas temperaturas e umidade. Não arrastar objetos sobre a superfície do móvel (ex.: TV, equipamentos eletrônicos, objetos decorativos...). Manter em local seco e arejado. Para a limpeza, utilizar um pano seco e macio. Não é necessário o uso de materiais abrasivos ou álcool.

No exponga el producto a la luz solar, las altas temperaturas y la humedad. No arrastre los objetos en la superficie de la unidad (por ejemplo, TV, equipos electrónicos, objetos de decoración ...). Mantener en un lugar fresco y seco. Para la limpieza, utilizar un paño seco y suave. El uso de materiales abrasivos o del alcohol no es necesario.

Do not expose the product to sunlight, high temperatures and humidity. Do not drag objects across the surface of the unit (TV, electronic equipments, decorative objects ...). Keep it in a cool and dry place. For cleaning, use a dry and soft cloth. Do not use abrasive materials or alcohol.

Garantia

Este certificado de Garantia é uma vantagem adicional oferecida ao consumidor, porém para que o mesmo tenha validade é imprescindível que seja apresentada a NOTA FISCAL de compra do produto.

Com este produto, a Artely tem como objetivo atender plenamente o proprietário-consumidor, proporcionando a garantia na forma aqui estabelecida, pelo período de três meses a partir da data da nota fiscal de compra. A Artely restringe a sua responsabilidade à substituição gratuita das peças defeituosas, em caso de defeitos ou avarias devidamente constatados como sendo de fabricação, durante a vigência desta garantia.

A Artely declara a garantia nula e sem efeito se o produto for alterado, adulterado, molhado ou consertado e ainda pela prática de montagem inadequada ou mau uso. Também será considerada nula em casos de força maior, como aqueles causados por agentes da Natureza (chuvas, incêndios, excesso de umidade, cupins,...) e eventos externos como objetos arrastados sobre a superfície do móvel (ex.: TV, DVD, aparelho de som, objetos decorativos...).

Para exercer seus direitos de comprador é importante que antes de montar seu produto você leia com atenção as instruções de cada passo do manual de montagem que acompanha o móvel.

Caso o produto não esteja em conformidade, entre em contato com a loja onde efetuou a compra e faça sua reclamação, apontando os defeitos técnicos observados. Para agilizar o seu atendimento, tenha sempre em mãos o manual de montagem com os respectivos números das peças defeituosas, conforme descritas no manual.

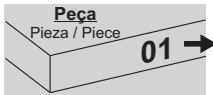



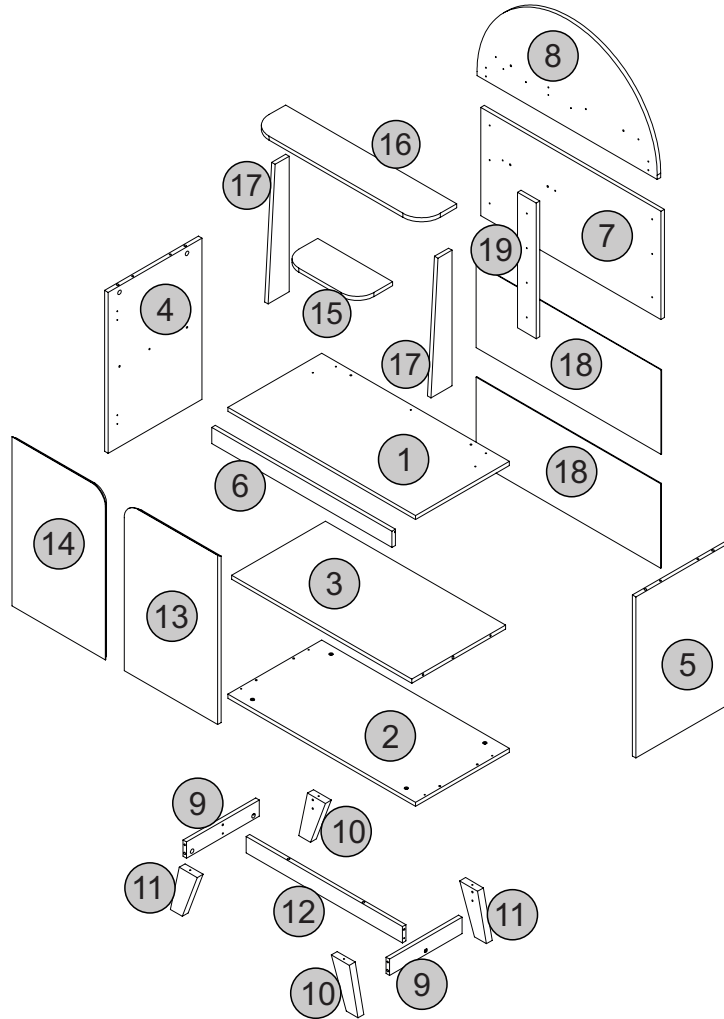
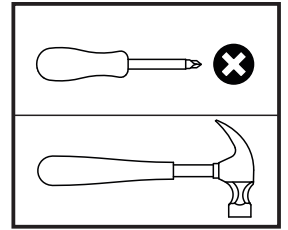







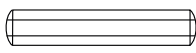

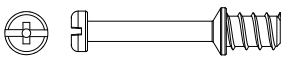
- O número na borda da peça corresponde ao manual.
- Para retirada do número usar Lustra-Móveis, Alcool em Gel ou Borracha.
- El número en el borde de la pieza coincide con el manual.
- Use una goma de borrar blanca, alcohol en gel o lustrador para muebles para eliminar los números.
- The number on the edge of the piece matches the manual.
- Use a White eraser, Alcohol Gel or Furniture Polish to remove the numbers.

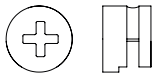
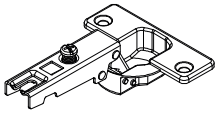

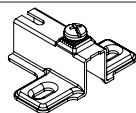
Descrição	Descripción	Description	Qty
1-Tampo (800x400x15mm)	1-Tapa	1-Top	1
2-Base (800x400x15mm)	2-Base	2-Base	1
3-Prateleira Fixa (678x400x15mm)	3-Estante Fijo	3-Fixed Shelf	1
4-Lateral Esquerda (595x400x15mm)	4-Lado izquierdo	4-Left side	1
5-Lateral Direita (595x400x15mm)	5-Lado derecho	5-Right side	1
6-Travessa Porta (768x60x15mm)	6-Bandeja de puerta	6-Door Tray	1
7-Painel Traseiro Inferior (768x400x15mm)	7-Panel trasero inferior	7-Lower Back Panel	1
8-Painel Traseiro Superior (768x400x15mm)	8-Panel trasero superior	8-Top Back Panel	1
9-Travessa dos Pés (310x60x15mm)	9-Riel de Pie	9-Foot Rail	2
10-Pé Esquerdo (180x77x25mm)	10-Pie Izquierdo	10-Left Foot	2
11-Pé Direito (180x77x25mm)	11-Pie Derecho	11-Right Foot	2
12-Travessa Base (666x60x15mm)	12-Bandeja básica	12-Base Tray	1
13-Porta Direita (625x398x15mm)	13-Puerta derecha	13-Right Door	1
14-Porta Esquerda (625x398x15mm)	14-Puerta izquierda	14-Left Door	1
15-Prateleira Menor (320x150x15mm)	15-Estante más pequeño	15-Smaller Shelf	1
16-Prateleira Superior (730x150x15mm)	16-Estante superior	16-Top Shelf	1
17-Travessa (500x90x15mm)	17-Plato	17-Platter	2
18-Traseiro (788x312x3mm)	18-Trasero	18-Rear	2
19-Travessa Traseiro (500x80x15mm)	19-Travesaño trasero	19-Rear Crossmember	1

Lista de Materiais

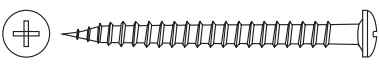
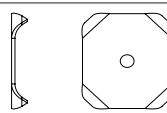
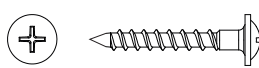
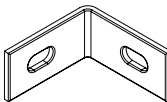
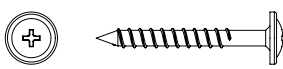
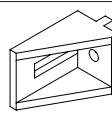
Lista de Materiales/ Hardware List

A		Cavilha / Tarugo / Dowel Ø6x30mm	22	J		Parafuso / Tornillo / Screw / Ø4,0x20mm CP	04
B		Minifix / Minifix / Minifix Ø7x30mm	12	K		Gancho / Gancho / Hook /	04
C		Tambor / Tambor / Minifix Cam Ø15x12mm	12	L		Dobradiça / Bisagra / Hinge /	04
D		Tapa furo adesivo / Adhesivo / Hole Cover Ø18mm	18	M		Calço Dobradiça / Cuña de Bisagra / Hinge Shim /	04
E		Parafuso Tornillo / Screw Ø4x14mm CP	26	N		Sapata Fixa / Pata Fija / Fixed Foot Ø5,0x10mm	04
F		Parafuso Tornillo / Screw Ø3,5x12mm CC	04	O		Prego / Clavo / Nail 8x8	25
G		Parafuso / Tornillo / Screw / Ø3,5x40mm CP	25	P		Fixador / fijador / Fixator	05
H		Parafuso / Tornillo / Screw / Ø3,5x25mm CF	02	Q		Cantoneira / Esquina / Coner	02
I		Parafuso / Tornillo / Screw / Ø5,0x40mm CF	06	R		Suporte / Soporte / Suport	03
				S		Produto Moldado / Silicona / Silicone 8mm	02

DICAS PARA FIXAR MINIFIX

TIP TO FASTEN THE MINIFIX
PISTA PARA ARREGLAR EL MINIFIX

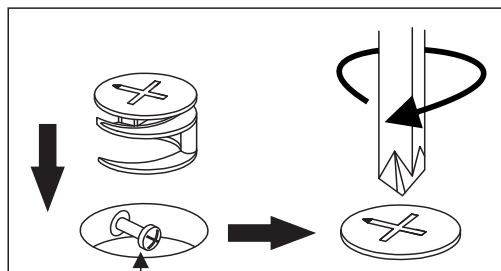

Cabeça do parafuso precisa estar no centro

La cabeza del tornillo debe estar en el centro
Screw head has to be in the center

Parafuso Minifix

Tornillo minifix/Minifix screw

Fixe o parafuso até o ressalto encostar na superfície da peça (veja o exemplo abaixo).

Tighten the screw until its overhang part lean on the piece surface (see the example below).

Fije el tornillo hasta que su parte sobresaliente toque la superficie de la pieza (vea el ejemplo abajo).

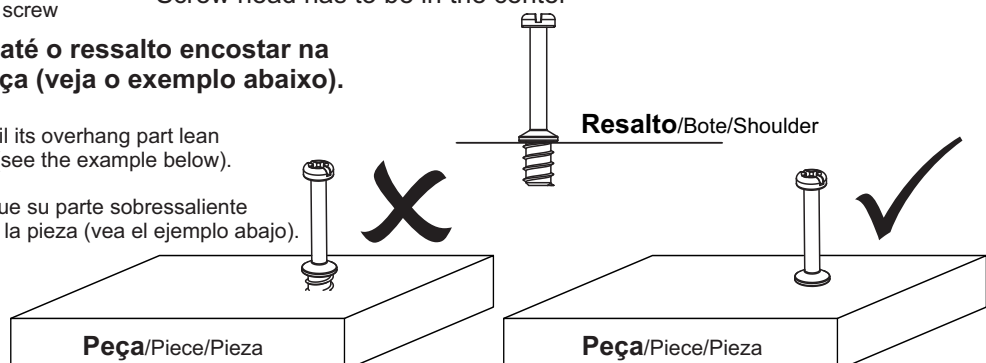

Passo 1

Paso/Step

PEÇA
Pieza/Piece

1 - TAMPO x1

2 - BASE x1

FERRAGEM
Herraje/Hardware

B  06

FERRAMENTA
Herramienta/Tool

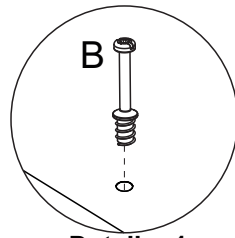
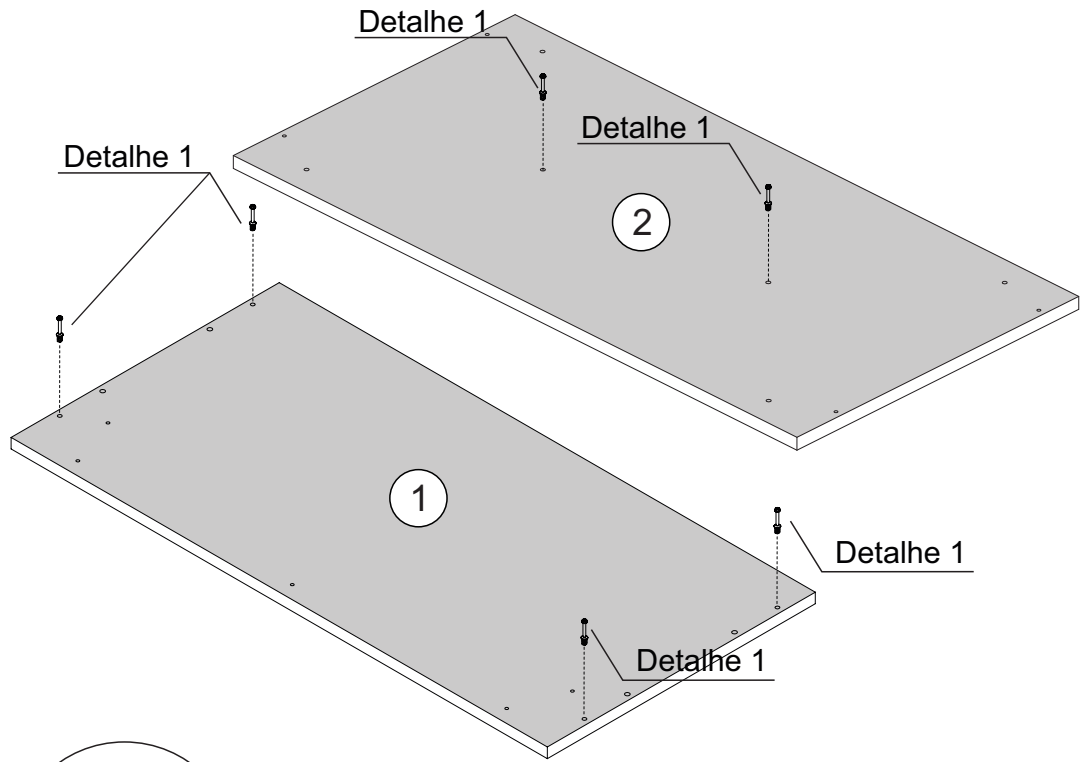
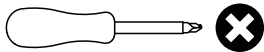

Detalhe 1
Detalle/Detail

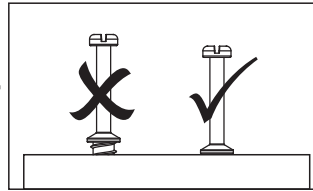

Passo 2

Paso/Step

PEÇA
Pieza/Piece

3 - PRATELEIRA FIXA x1

FERRAGEM
Herraje/Hardware

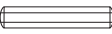
A  04

FERRAMENTA
Herramienta/Tool

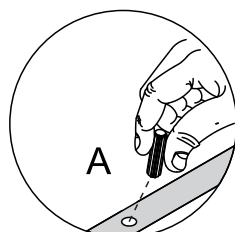
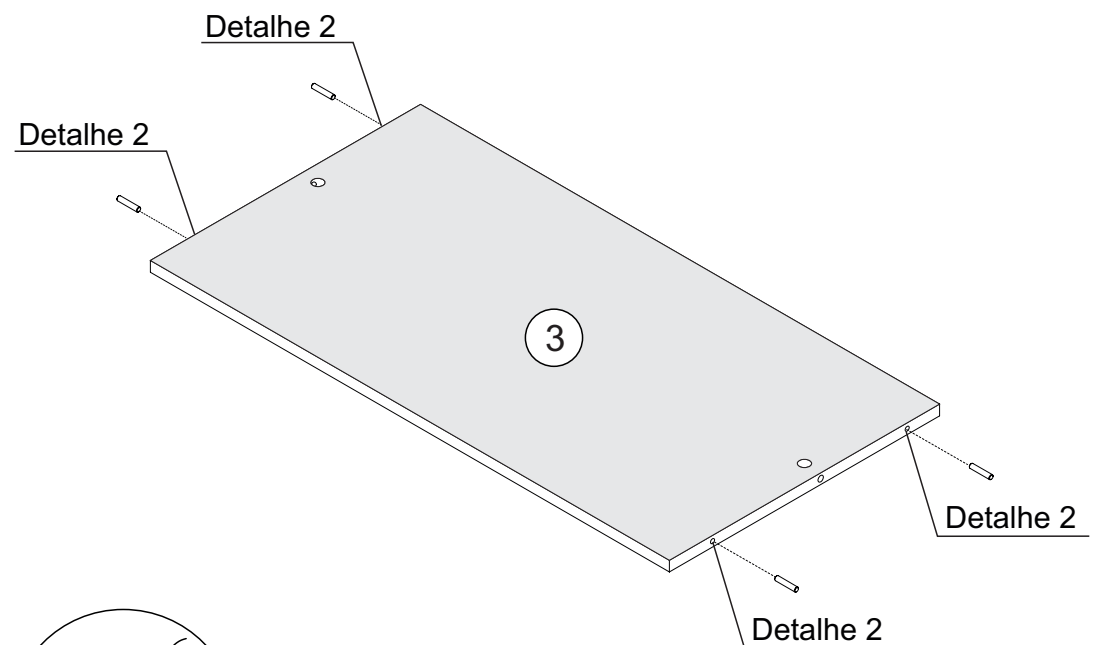
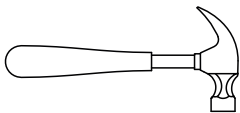

Detalhe 2
Detalle/Detail

Passo 3

Paso/Step

PEÇA
Pieza/Piece

4 - LATERAL ESQUERDA x1

FERRAGEM
Herraje/Hardware

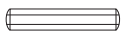
A  04

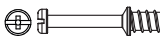
B  01

E  04

M  02

FERRAMENTA
Herramienta/Tool

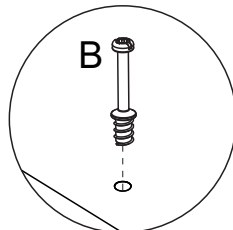
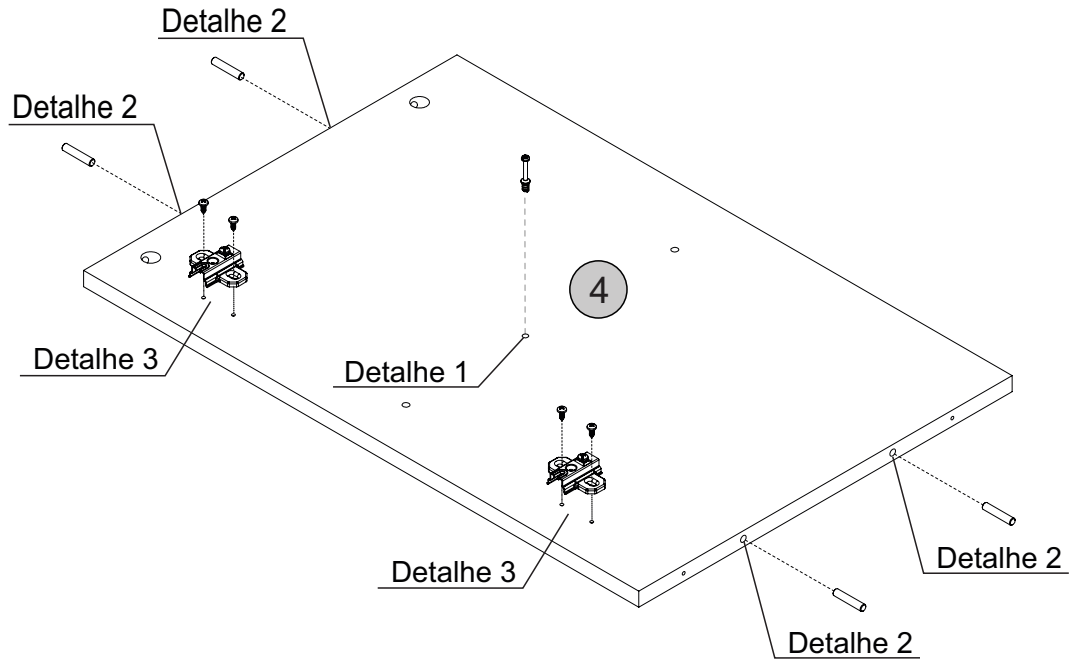
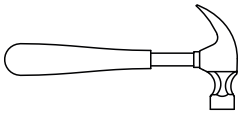
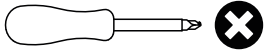

Detalhe 1
Detalle/Detail

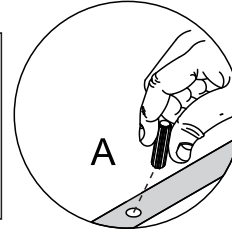
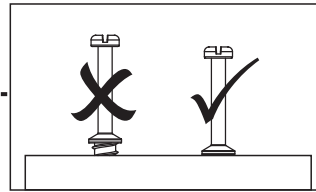

Detalhe 2
Detalle/Detail

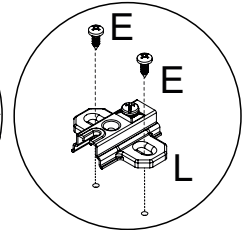

Detalhe 3
Detalle/Detail

Passo 4

Paso/Step

PEÇA
Pieza/Piece

5 - LATERAL DIREITA x1

FERRAGEM
Herraje/Hardware

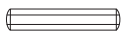
A  04

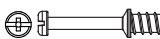
B  01

E  04

M  02

FERRAMENTA
Herramienta/Tool

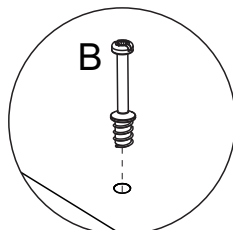
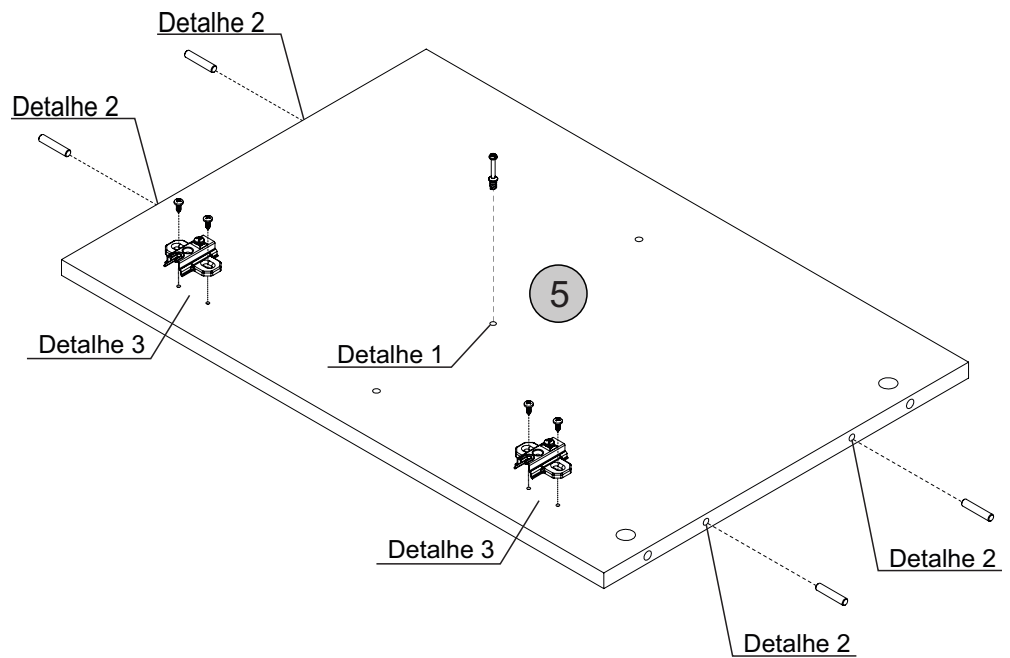
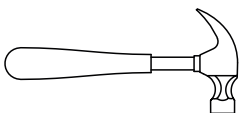
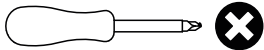

Detalhe 1
Detalle/Detail

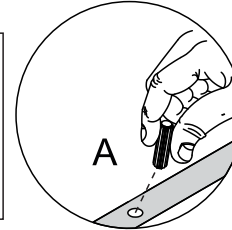
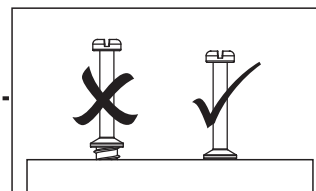

Detalhe 2
Detalle/Detail

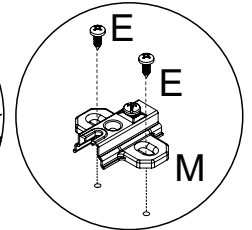

Detalhe 3
Detalle/Detail

Passo 5

Paso/Step

PEÇA

Pieza/Piece

7 - PAINEL TRASEIRO INF. x1

FERRAGEM

Herraje/Hardware

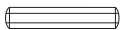
A  02

FERRAMENTA

Herramienta/Tool

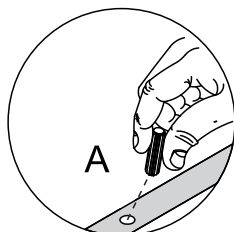
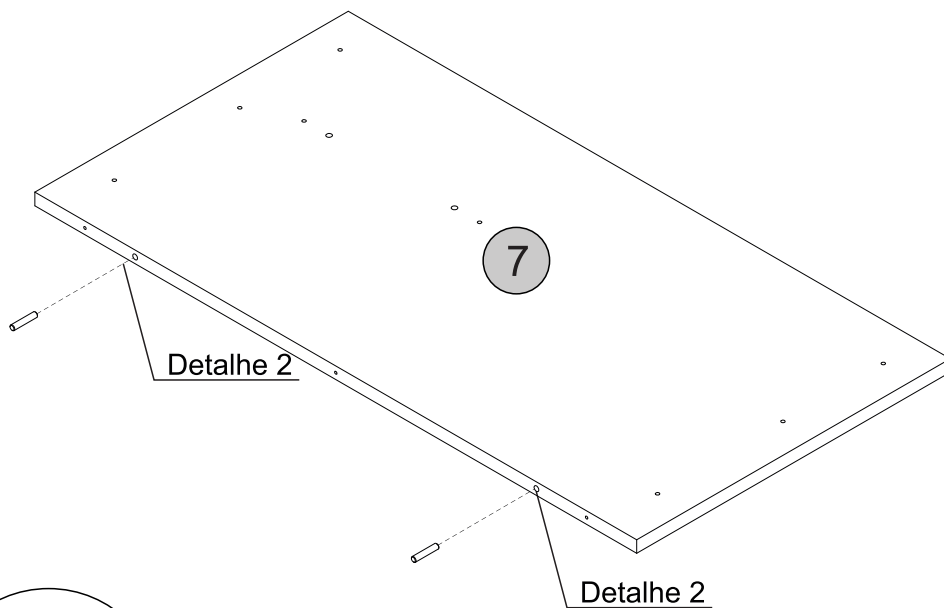
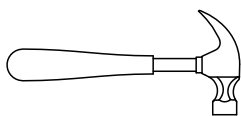

Detalhe 2
Detalle/Detail

Passo 6

Paso/Step

PEÇA

Pieza/Piece

8 - PAINEL TRASEIRO SUP. x1

FERRAGEM

Herraje/Hardware

F  04

K  04

FERRAMENTA

Herramienta/Tool

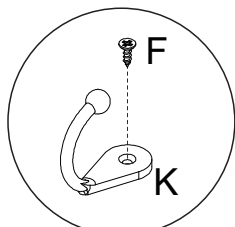
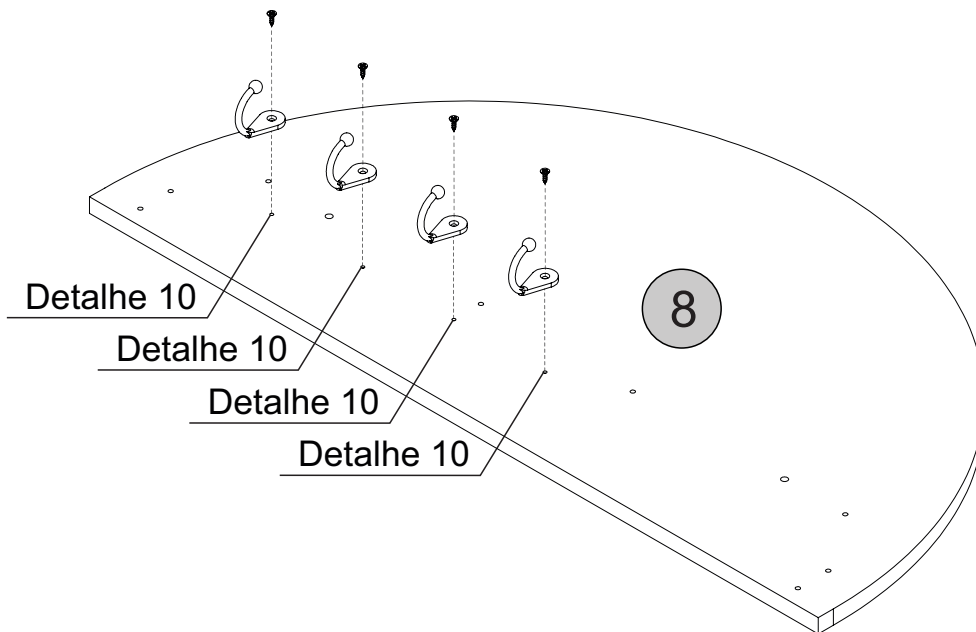
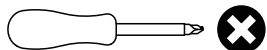

Detalhe 10
Detalle/Detail

Passo 7

Paso/Step

PEÇA

Pieza/Piece

16 - PRATELEIRA SUPERIOR x1

FERRAGEM

Herraje/Hardware

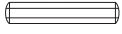
A  02

FERRAMENTA

Herramienta/Tool

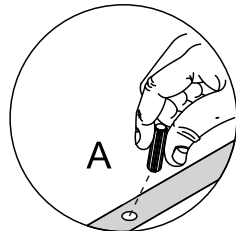
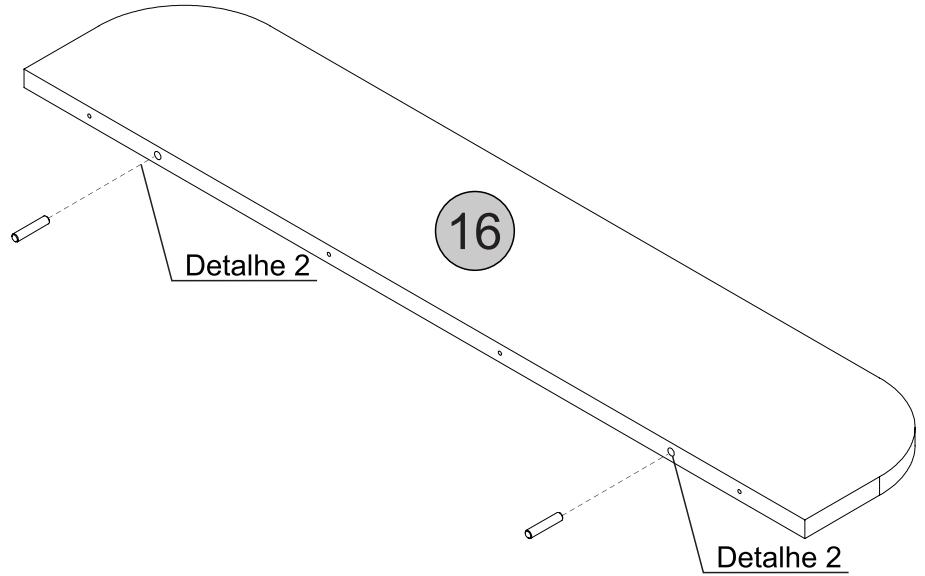
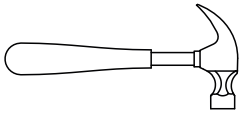

Detalhe 2
Detalle/Detail

Passo 8

Paso/Step

PEÇA

Pieza/Piece

16 - PRATELEIRA SUPERIOR x1

FERRAGEM

Herraje/Hardware

A  02

FERRAMENTA

Herramienta/Tool

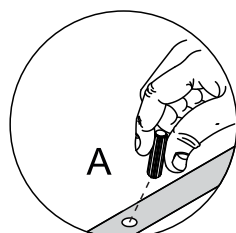
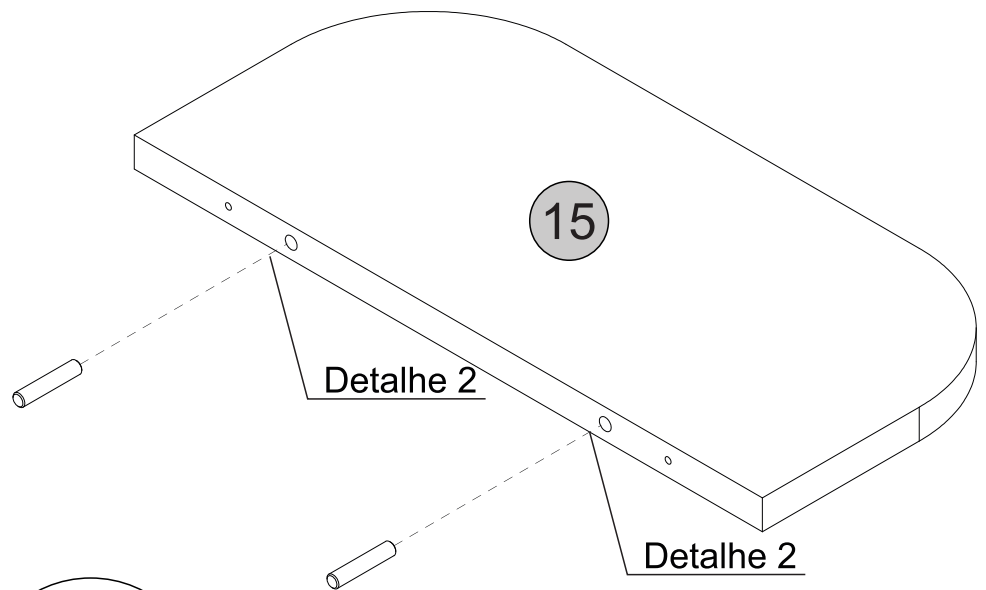
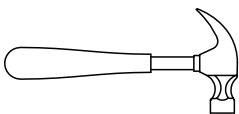

Detalhe 2
Detalle/Detail

Passo 9

Paso/Step

PEÇA
Pieza/Piece

10 - PÉ ESQUERDO x2

11 - PÉ DIREITO x2

FERRAGEM
Herraje/Hardware

B  04

N  04

FERRAMENTA
Herramienta/Tool

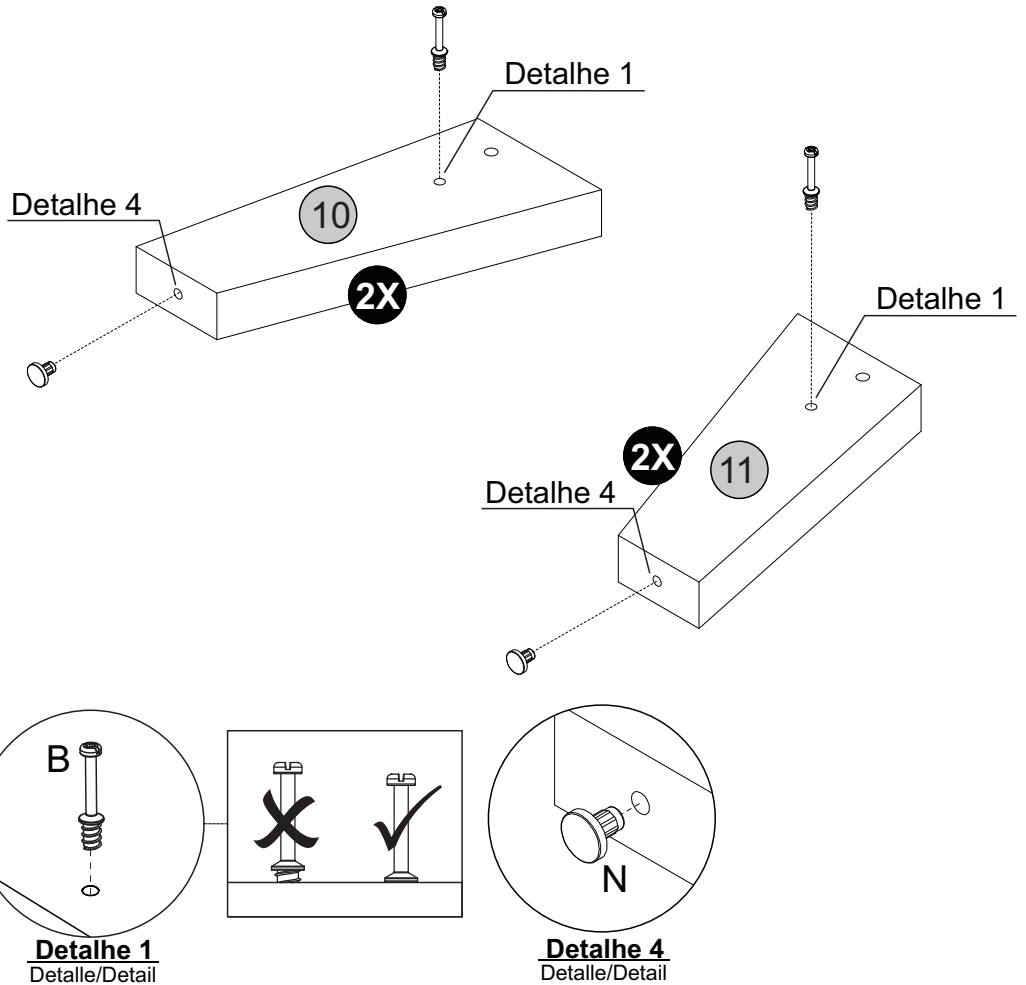
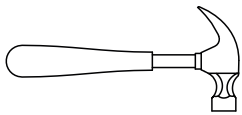
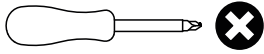

Passo 10

Paso/Step

PEÇA
Pieza/Piece

9 - TRAVESSA DOS PÉS x2

FERRAGEM
Herraje/Hardware

A  04

FERRAMENTA
Herramienta/Tool

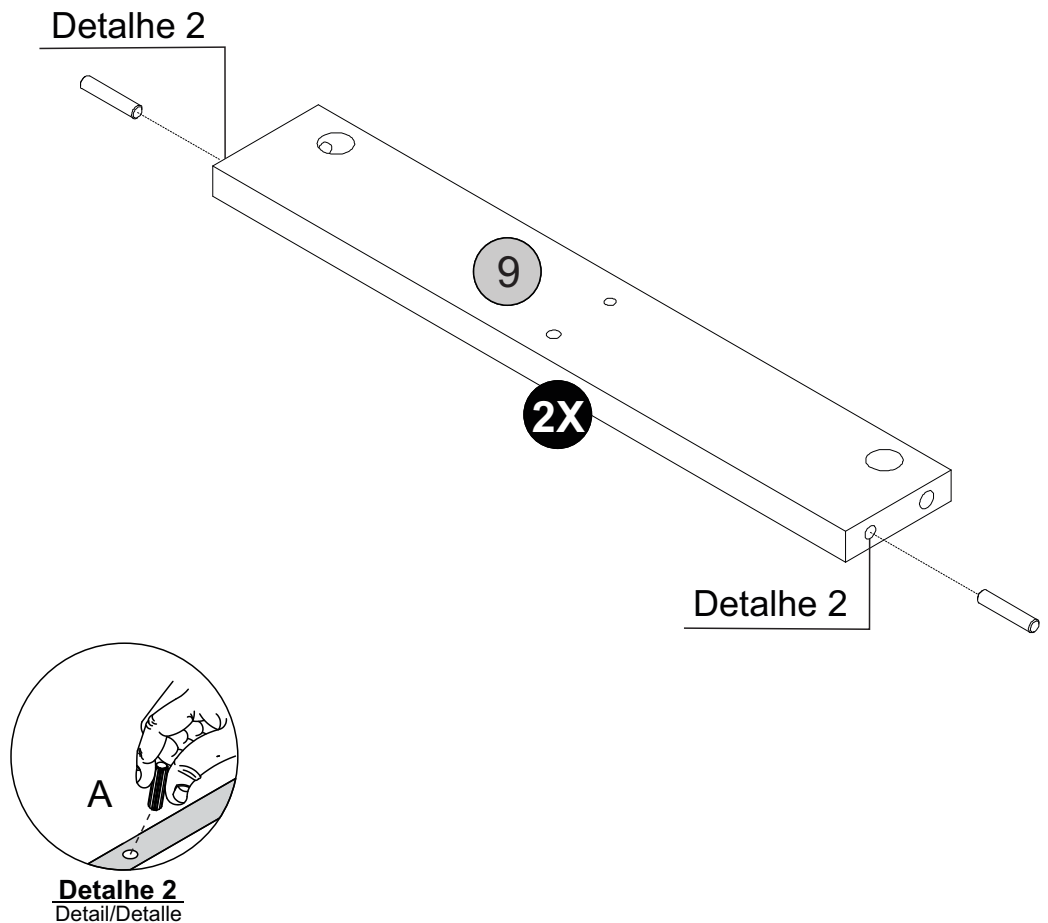
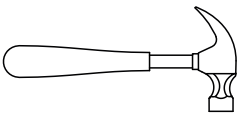

Passo 11

Paso/Step

PEÇA
Pieza/Piece

12 - TRAVESSA BASE x1

FERRAGEM
Herraje/Hardware

A  02

FERRAMENTA
Herramienta/Tool

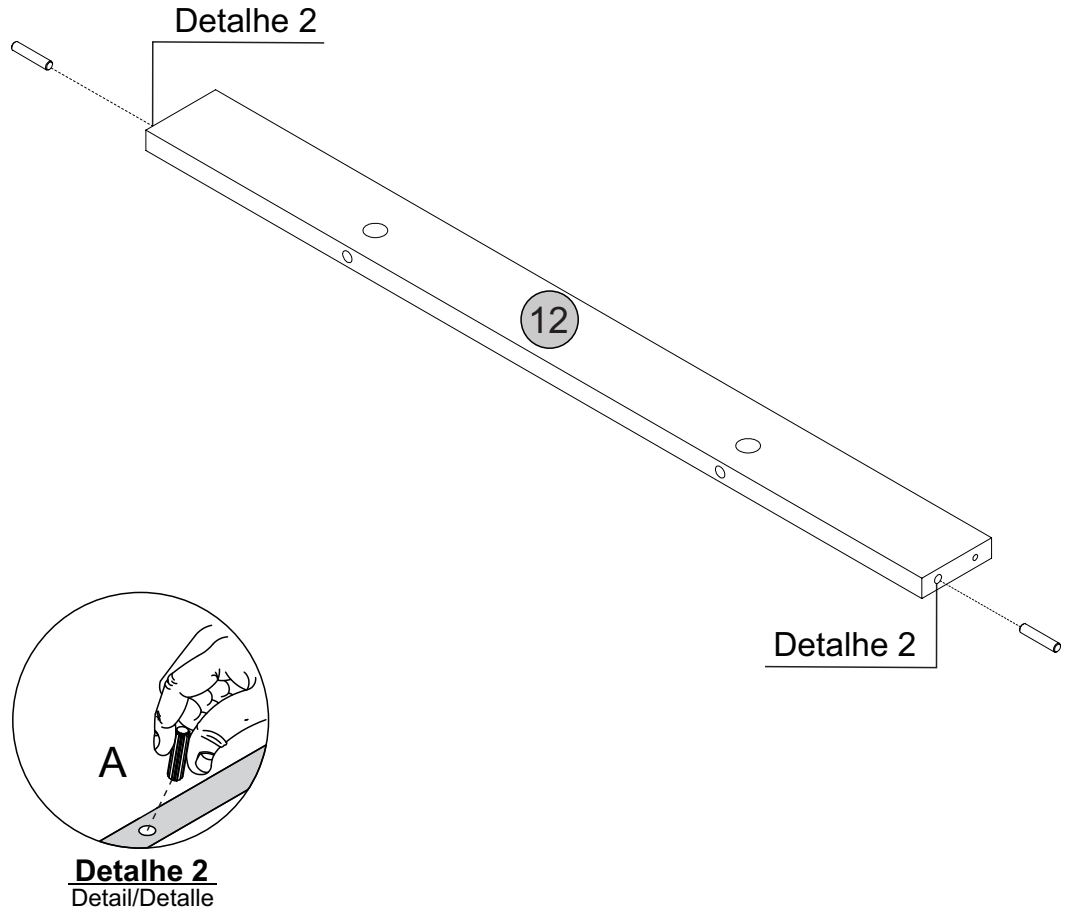
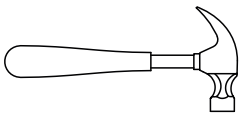

Passo 12

Paso/Step

PEÇA
Pieza/Piece

06 - TRAVESSA PORTA x1

FERRAGEM
Herraje/Hardware

Q  02

R  03

E  05

FERRAMENTA
Herramienta/Tool

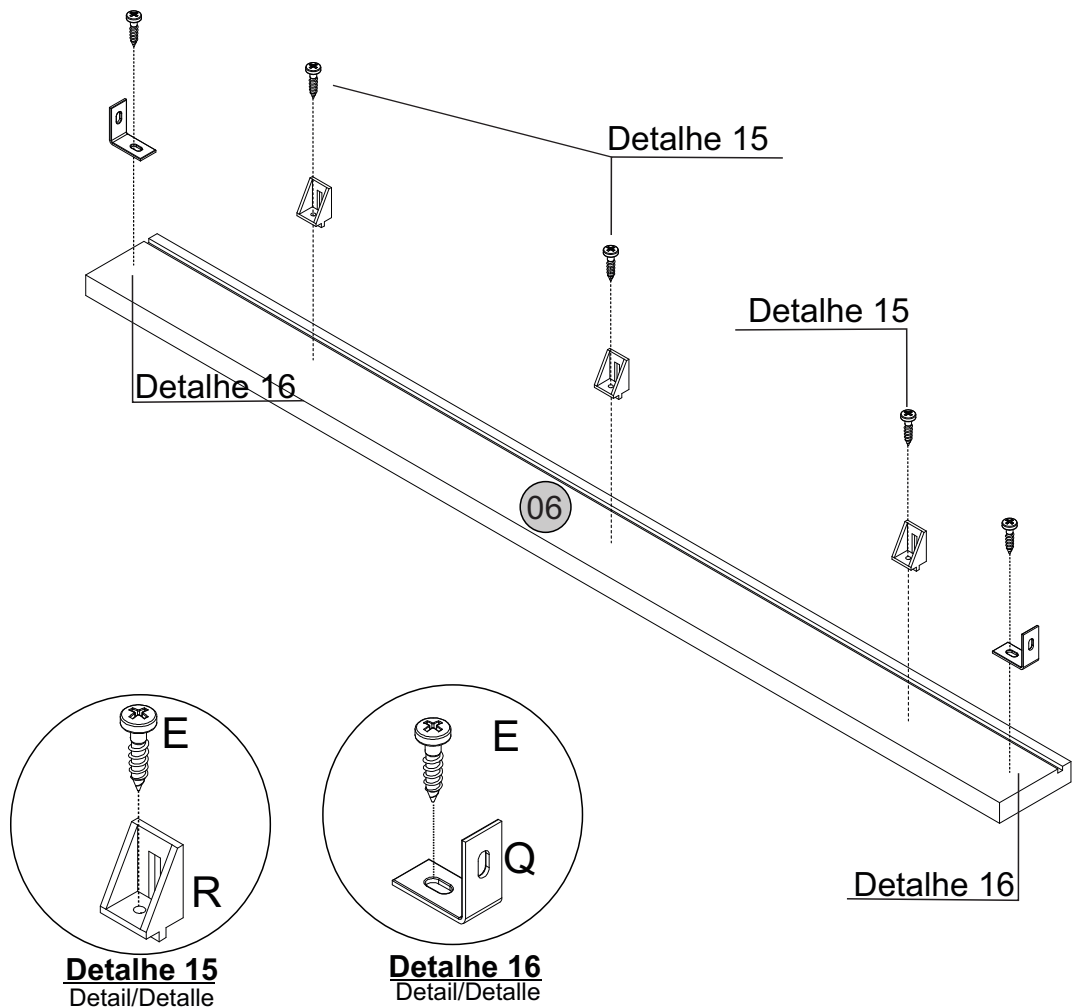
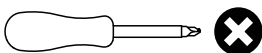

Passo 13

Paso/Step

PEÇA
Pieza/Piece

14 - PORTA ESQUERDA x1

FERRAGEM
Herraje/Hardware

E  04

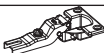
L  02

FERRAMENTA
Herramienta/Tool

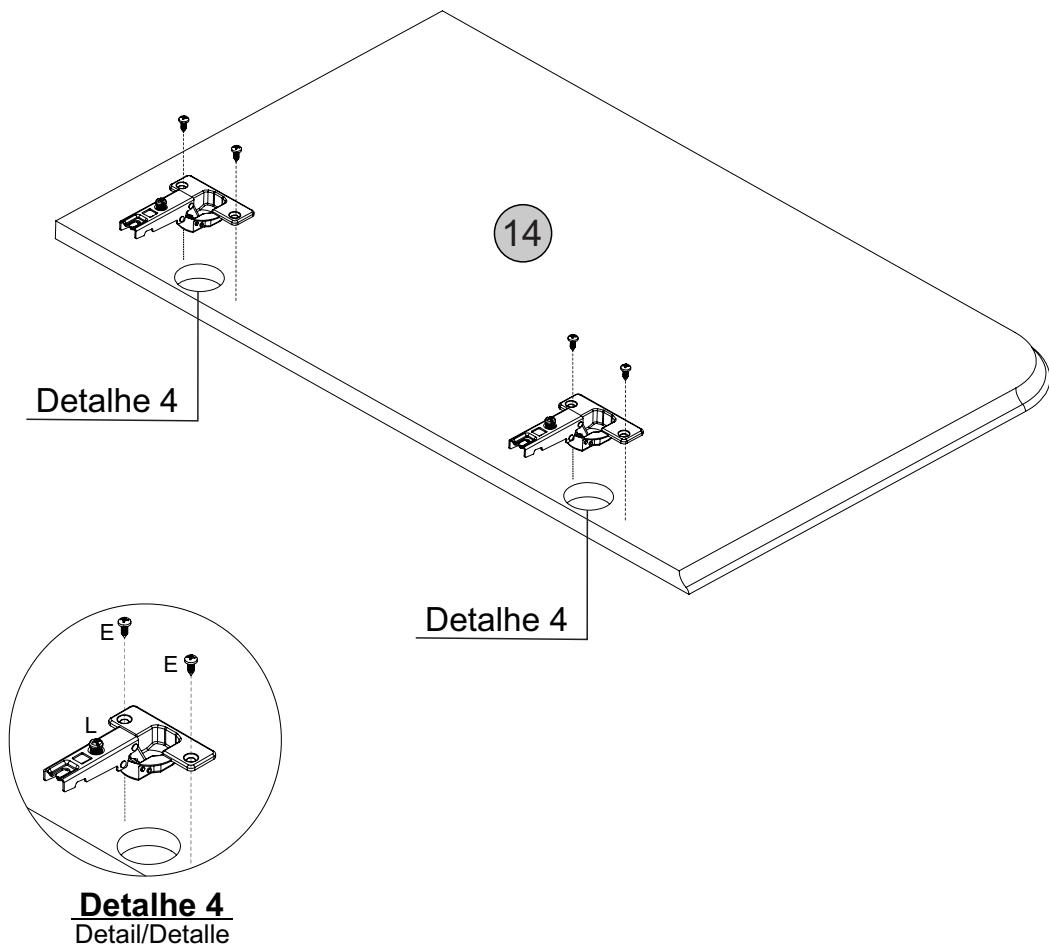
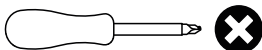

Passo 14

Paso/Step

PEÇA
Pieza/Piece

13 - PORTA DIREITA x1

FERRAGEM
Herraje/Hardware

E  04

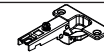
L  02

FERRAMENTA
Herramienta/Tool

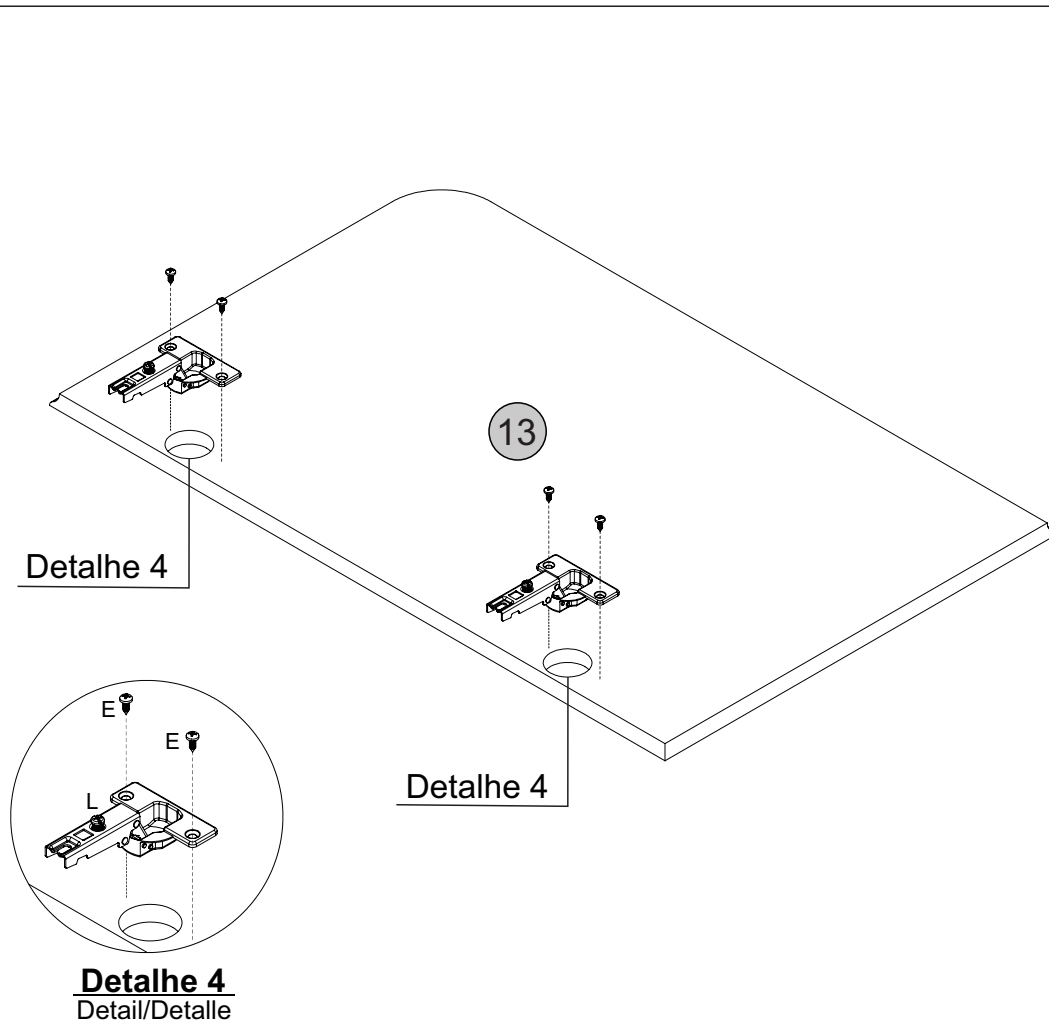
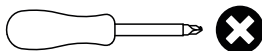

Passo 15

Paso/Step

PEÇA
Pieza/Piece

9 - TRAVESSA DOS PÉS x2

12 - TRAVESSA BASE x1

FERRAGEM
Herraje/Hardware

D  x2

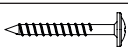
I  x2

FERRAMENTA
Herramienta/Tool

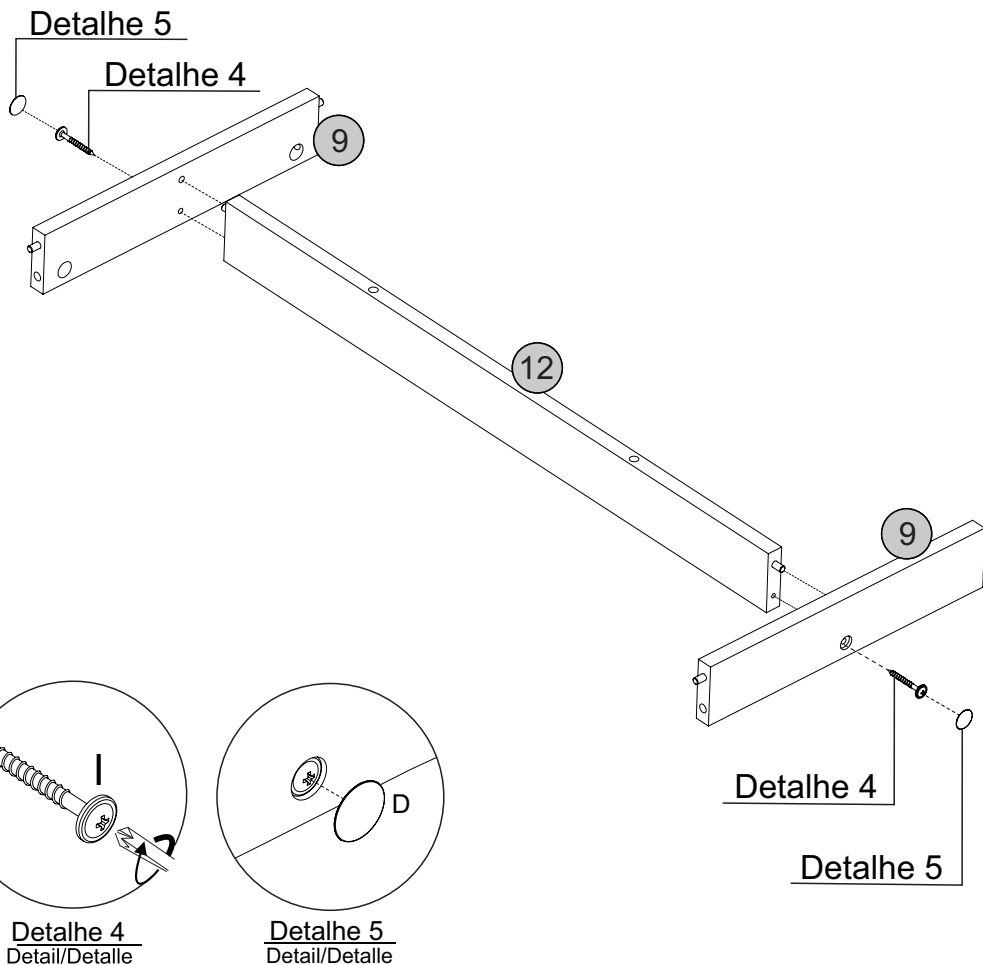
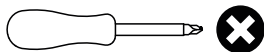

Passo 16

Paso/Step

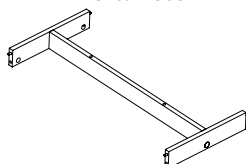

PEÇA
Pieza/Piece



10 - PÉ ESQUERDO x2

11 - PÉ DIREITO x2

FERRAGEM
Herraje/Hardware

C   x4

D  x4

FERRAMENTA
Herramienta/Tool

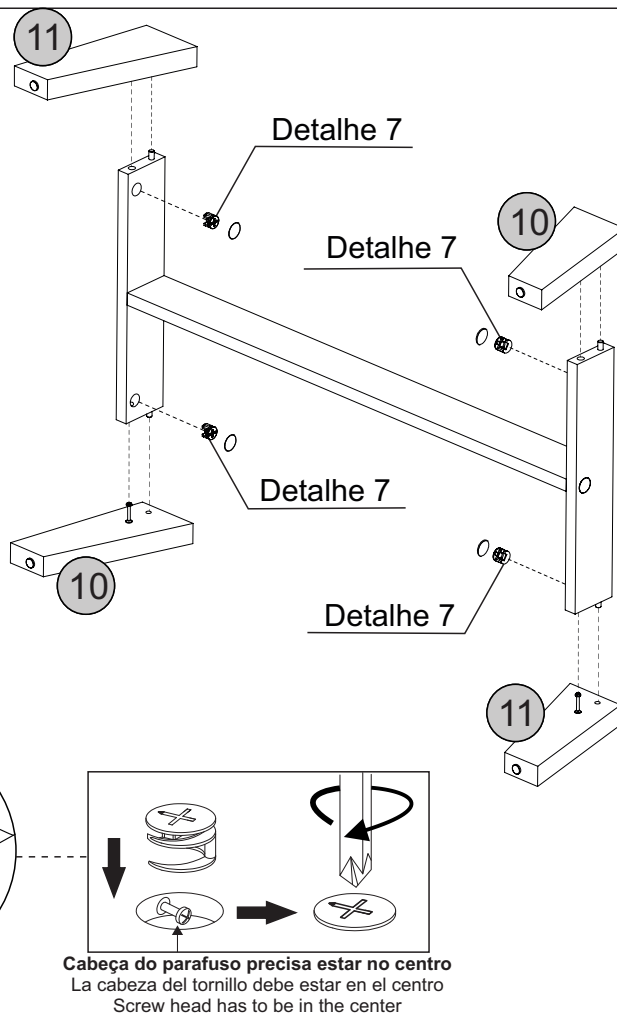
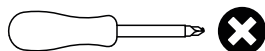

Passo 17

Paso/Step

PEÇA
Pieza/Piece

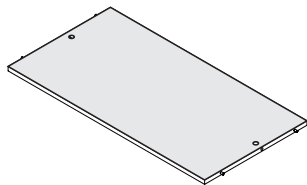

4 - LATERAL ESQUERDA x1

FERRAGEM
Herraje/Hardware

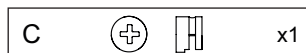

FERRAMENTA
Herramienta/Tool

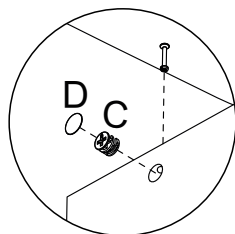
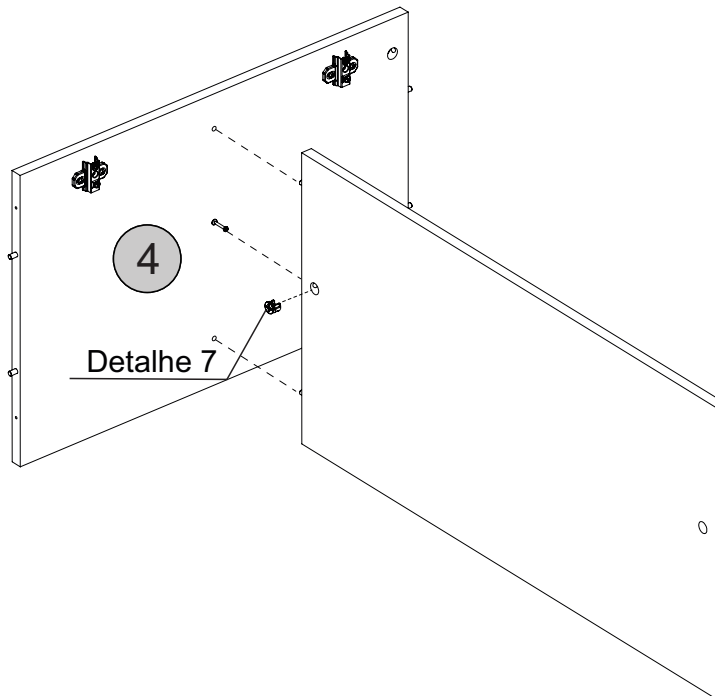
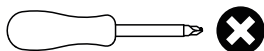

Detalhe 7
Detalle/Detail

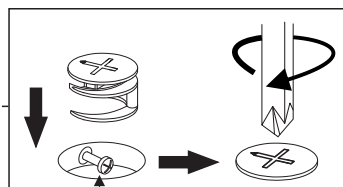

Cabeça do parafuso precisa estar no centro
La cabeza del tornillo debe estar en el centro
Screw head has to be in the center

Passo 18

Paso/Step

PEÇA
Pieza/Piece

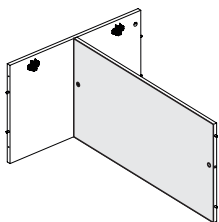

5 - LATERAL DIREITA x1

FERRAGEM
Herraje/Hardware

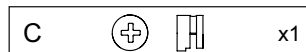

FERRAMENTA
Herramienta/Tool

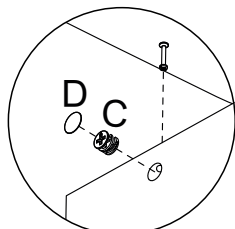
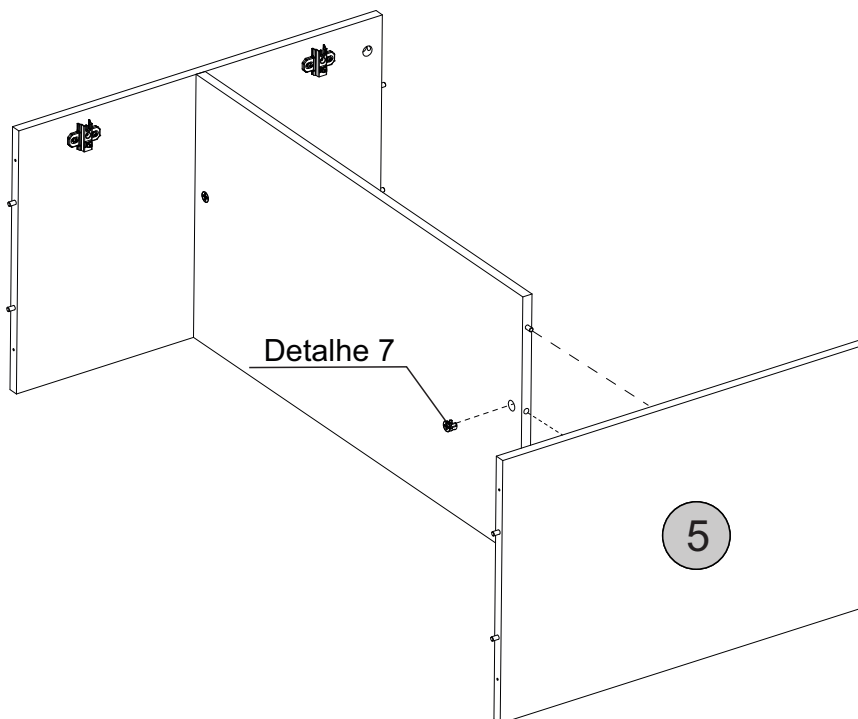
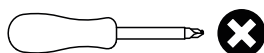

Detalhe 7
Detalle/Detail

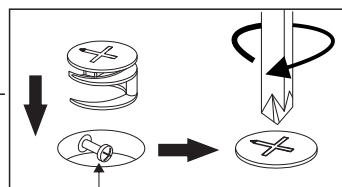

Cabeça do parafuso precisa estar no centro
La cabeza del tornillo debe estar en el centro
Screw head has to be in the center

Passo 19

Paso/Step

PEÇA
Pieza/Piece

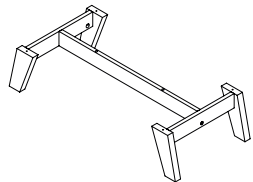

2-BASE

x1

FERRAGEM
Herraje/Hardware

C   x2

D  x2

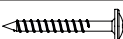
I  x8

FERRAMENTA
Herramienta/Tool

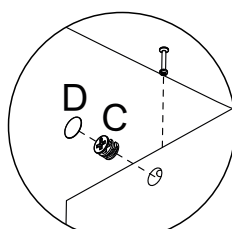
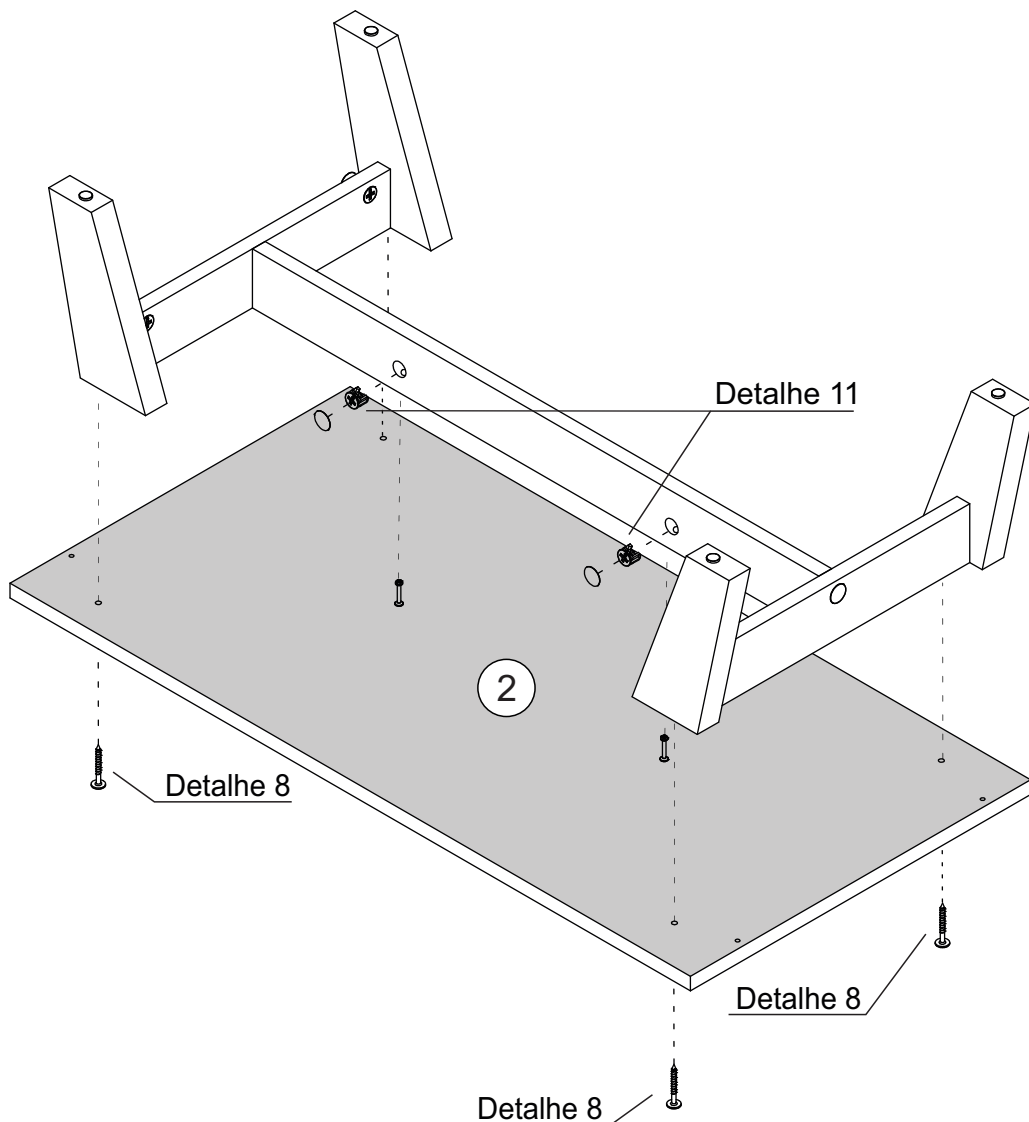
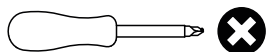

Detalhe 7
Detalle/Detail

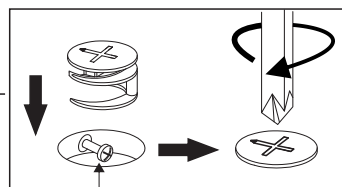

Cabeça do parafuso precisa estar no centro
La cabeza del tornillo debe estar en el centro
Screw head has to be in the center

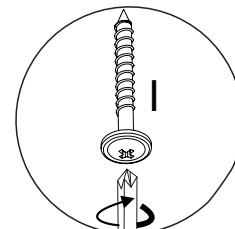

Detalhe 8
Detail/Detalle

Passo 20

Paso/Step

PEÇA
Pieza/Piece

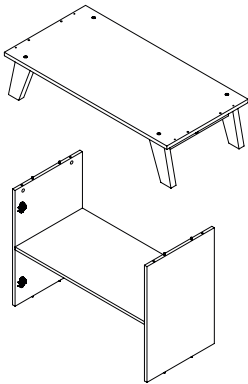

FERRAGEM
Herraje/Hardware



FERRAMENTA
Herramienta/Tool

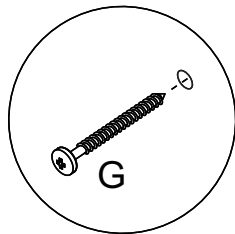
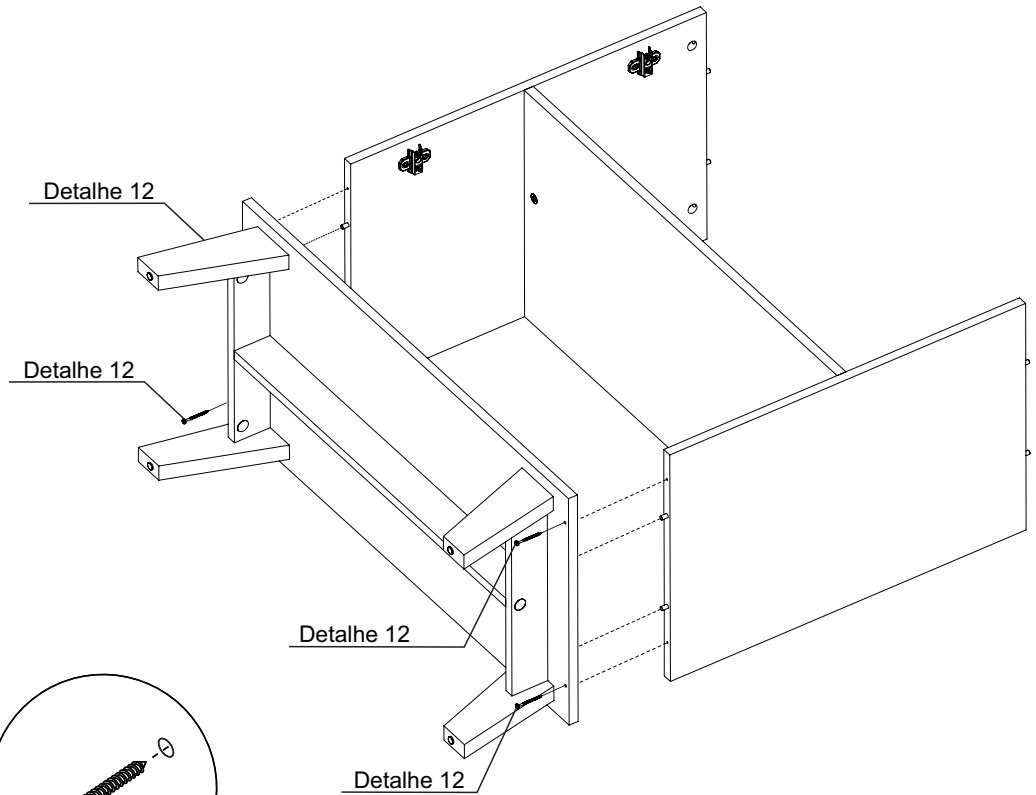
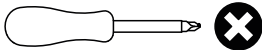

Detalhe 12
Detalle/Detail

Passo 21

Paso/Step

PEÇA
Pieza/Piece

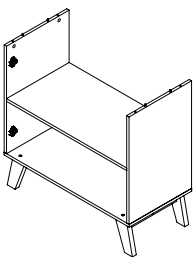

1 - TAMPO x1

FERRAGEM
Herraje/Hardware

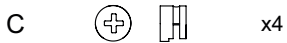

FERRAMENTA
Herramienta/Tool

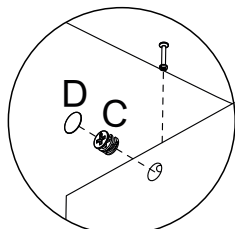
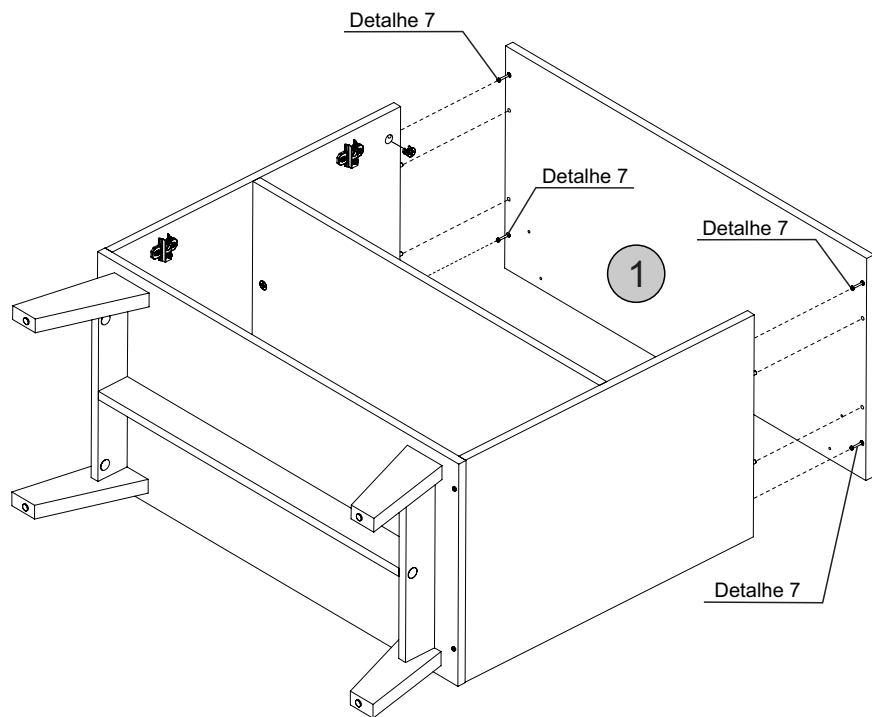
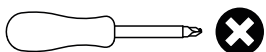

Detalhe 7
Detalle/Detail

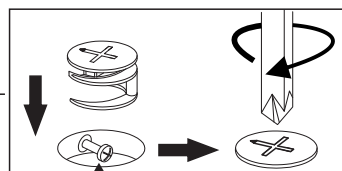

Cabeça do parafuso precisa estar no centro
La cabeza del tornillo debe estar en el centro
Screw head has to be in the center

Passo 22

Paso/Step

PEÇA

Pieza/Piece

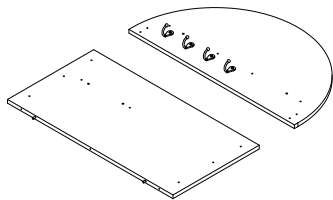

19 - TRAVESSA TRASEIRO x1

FERRAGEM

Herraje/Hardware

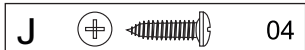

FERRAMENTA

Herramienta/Tool

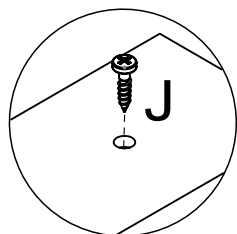
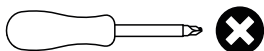

Detalhe 7
Detail/Detaille

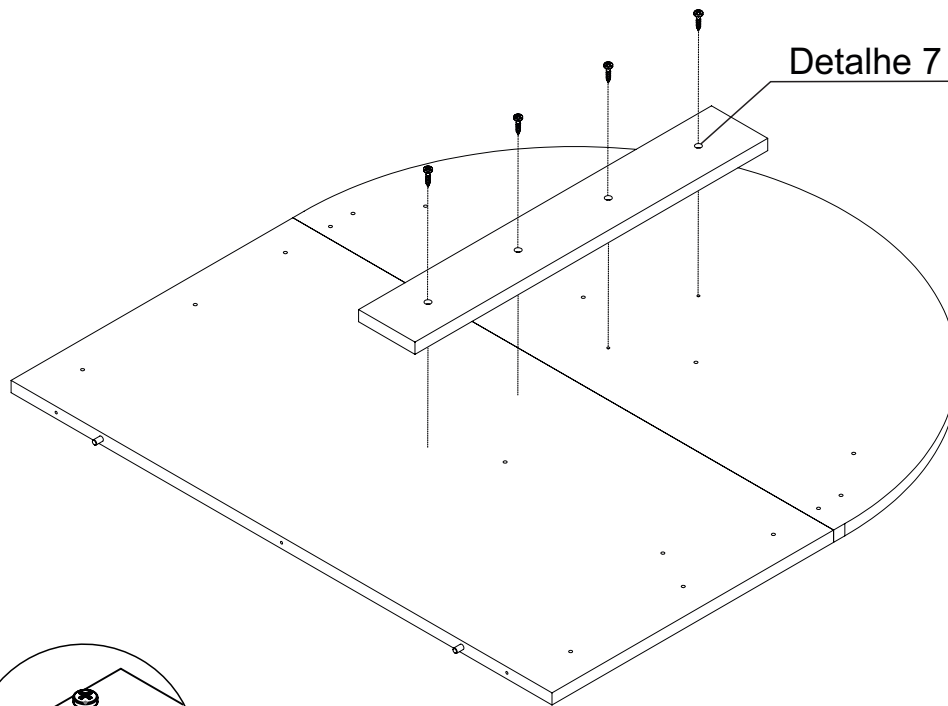

Passo 23

Paso/Step

PEÇA

Pieza/Piece

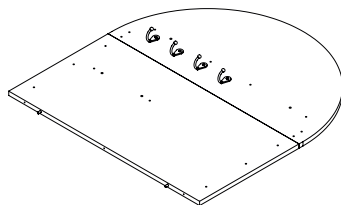

17 - TRAVESSA x1

FERRAGEM

Herraje/Hardware



FERRAMENTA

Herramienta/Tool

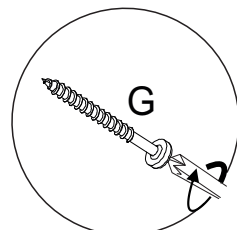
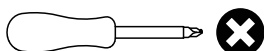

Detalhe 12
Detail/Detaille

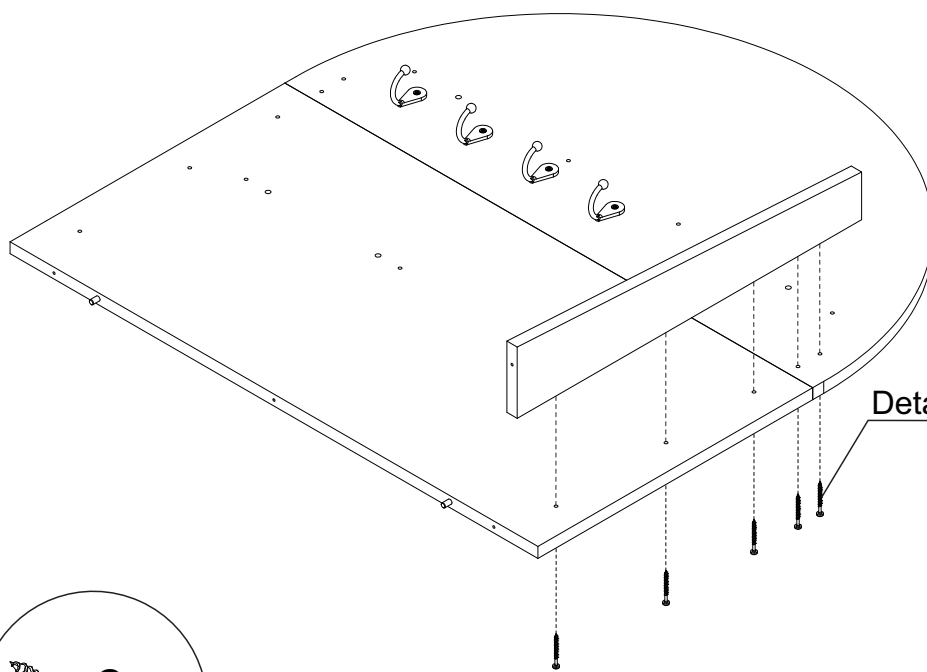

Detalhe 12

Passo 24

Paso/Step

PEÇA

Pieza/Piece

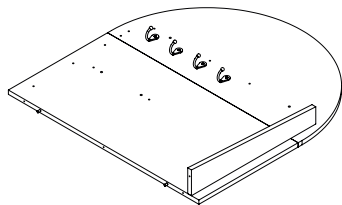

17 - TRAVESSA x1

FERRAGEM

Herraje/Hardware

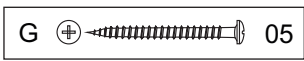

FERRAMENTA

Herramienta/Tool

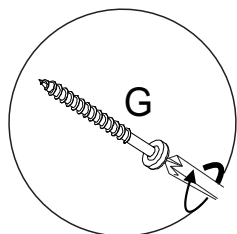
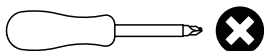

Detalhe 12
Detail/Detalle

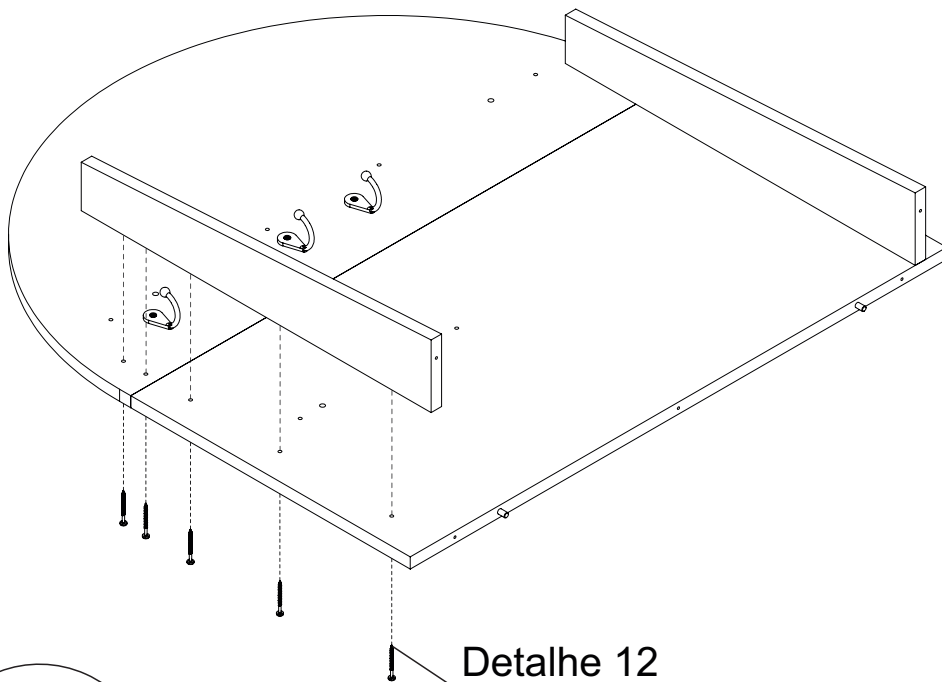

Passo 25

Paso/Step

PEÇA

Pieza/Piece

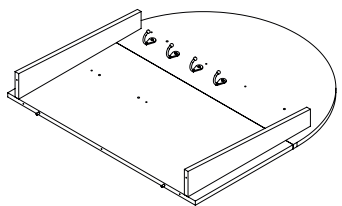

15 - PRATELEIRA MENOR x1

FERRAGEM

Herraje/Hardware

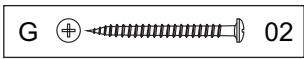

FERRAMENTA

Herramienta/Tool

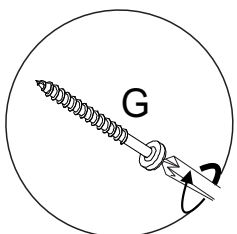
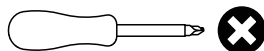

Detalhe 12
Detail/Detalle

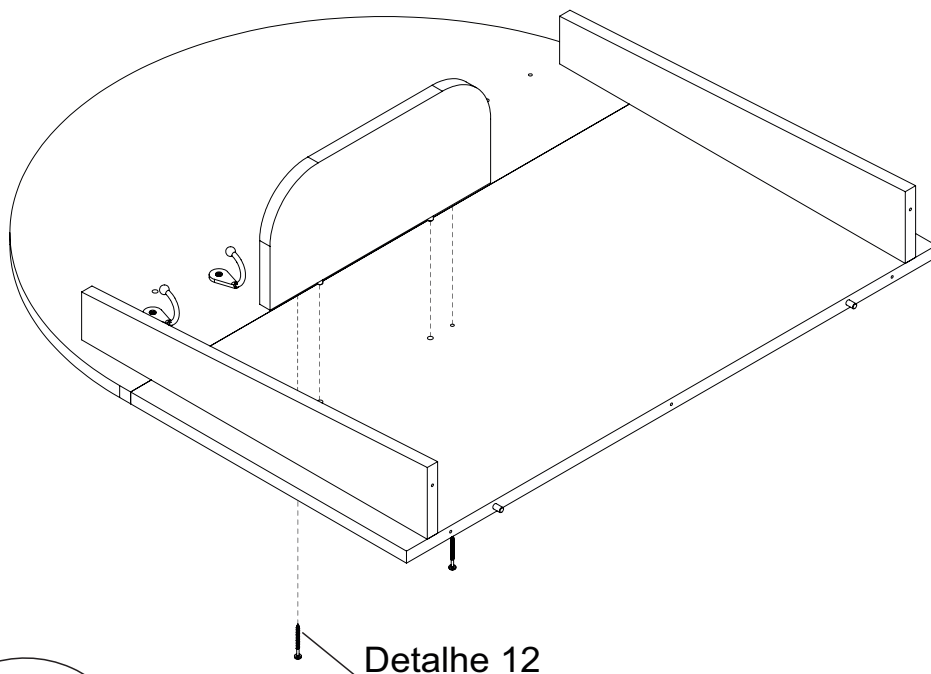

Passo 26

Paso/Step

PEÇA

Pieza/Piece

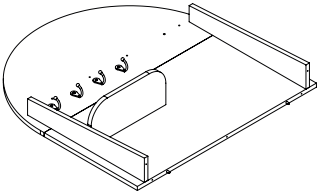

16 - PRATELEIRA SUPERIOR x1

FERRAGEM

Herraje/Hardware

G  04

FERRAMENTA

Herramienta/Tool

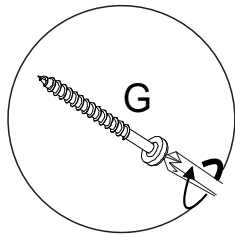
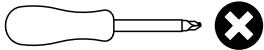

Detalhe 12
Detail/Detaille

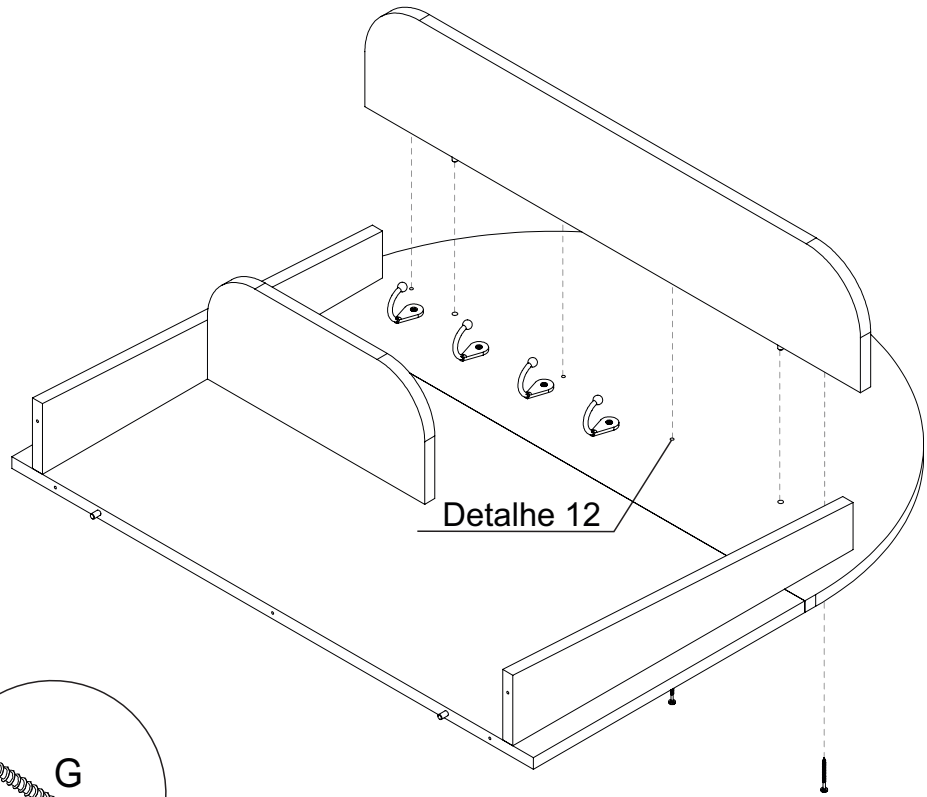

Passo 27

Paso/Step

PEÇA

Pieza/Piece

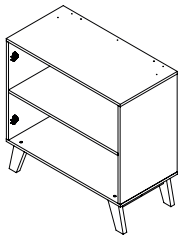
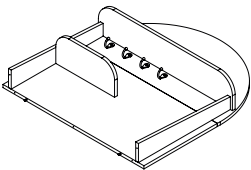

FERRAGEM

Herraje/Hardware

G  05

FERRAMENTA

Herramienta/Tool

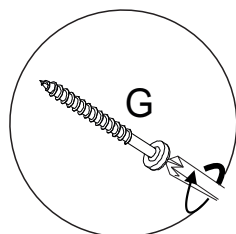
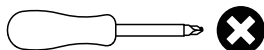

Detalhe 12
Detail/Detaille

Detalhe 12

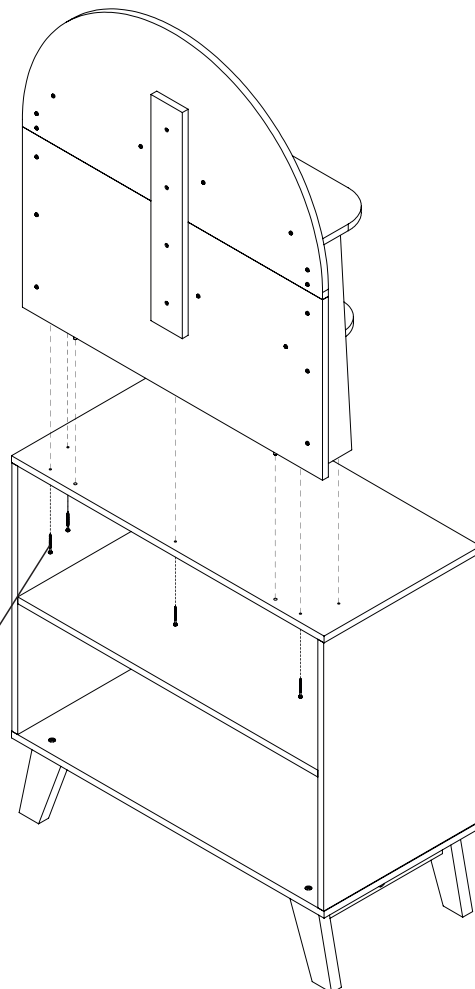

Passo 28

Paso/Step

PEÇA
Pieza/Piece

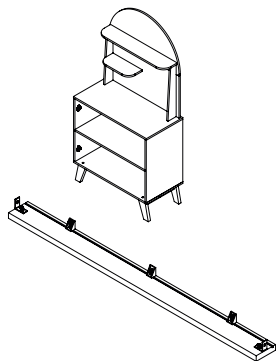

6 - TRAVESSA PORTA x1

FERRAGEM
Herraje/Hardware



FERRAMENTA
Herramienta/Tool

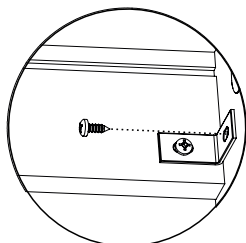
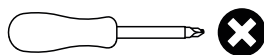

Detalhe 18
Detail/Detalle

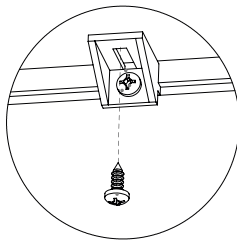

Detalhe 19
Detail/Detalle

Detalhe 19

Detalhe 18

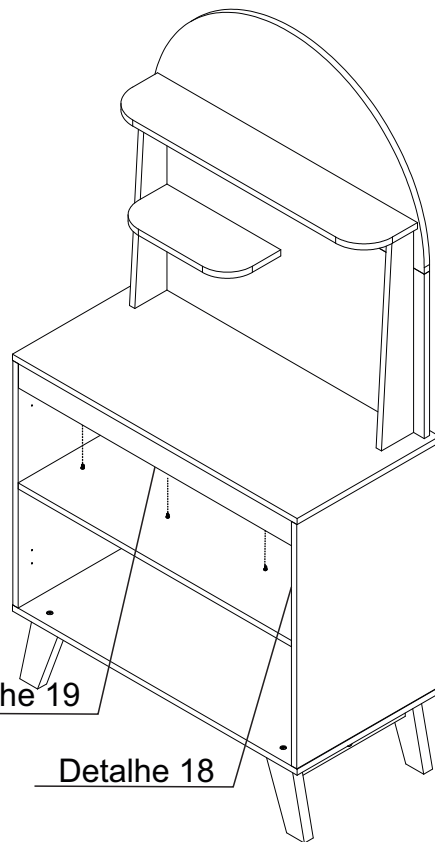

Passo 29

Paso/Step

PEÇA
Pieza/Piece

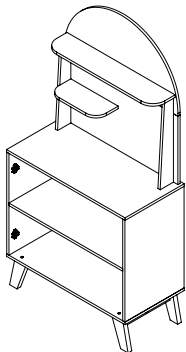

13 - PORTA DIREITA x2

14 - PORTA ESQUERDA x2

FERRAMENTA
Herramienta/Tool

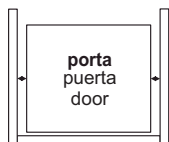
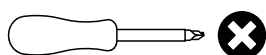

Ajuste de Largura
Ajuste de ancho
Width Adjustment



Ajuste Interno
Ajuste Interno
Internal Adjustment



Ajuste de Profundidade
Ajuste de profundidad
Depth Adjustment

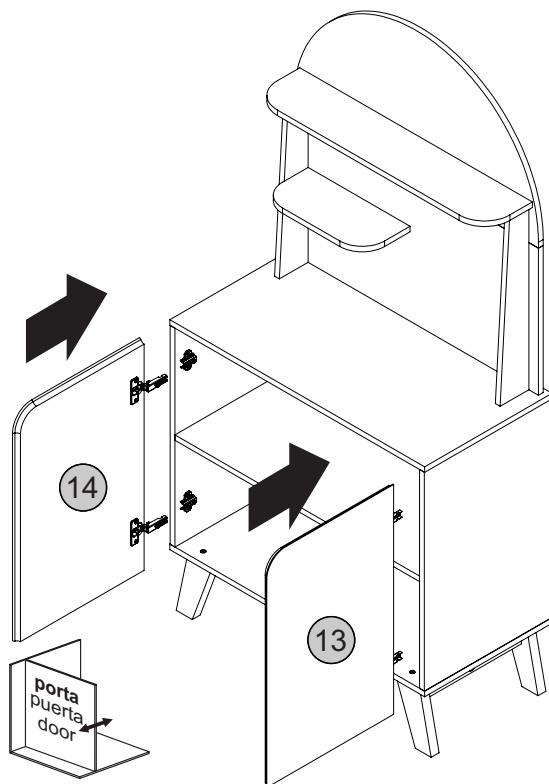
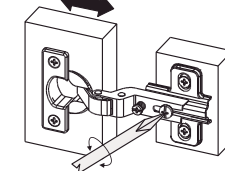
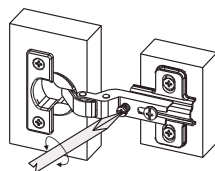
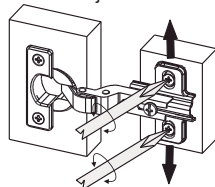

Passo 30

Paso/Step

PEÇA
Pieza/Piece

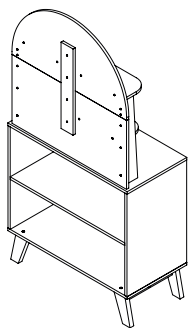

18 - TRASEIRO

x2

FERRAGEM
Hardware/Herraje

O  25

P  05

FERRAMENTA
Herramienta/Tool

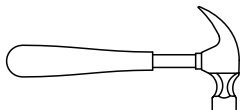

Detalhe 13

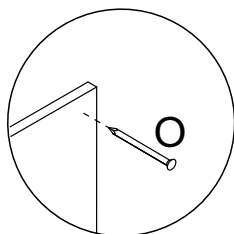

Detalhe 13
Detail/Detalle

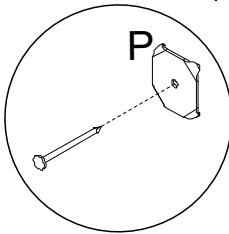

Detalhe 14
Detail/Detalle

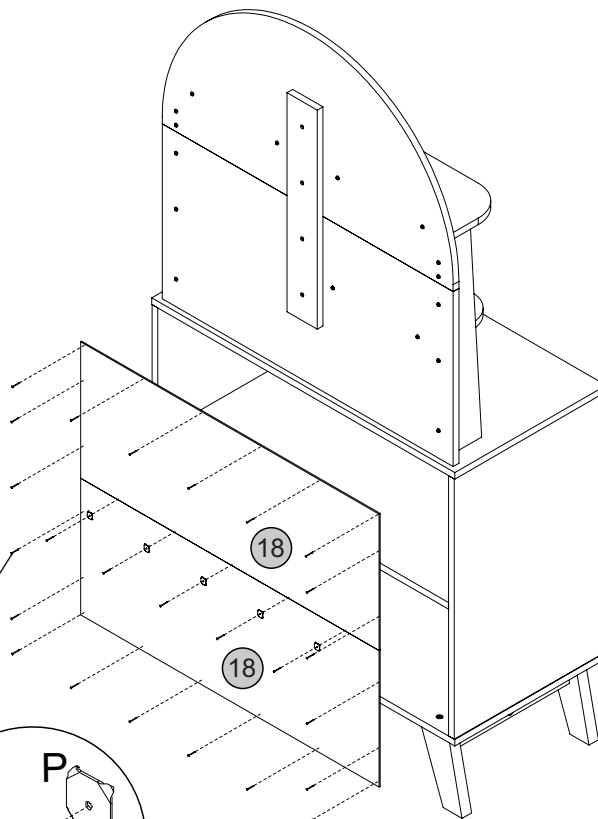

Passo 31

Paso/Step

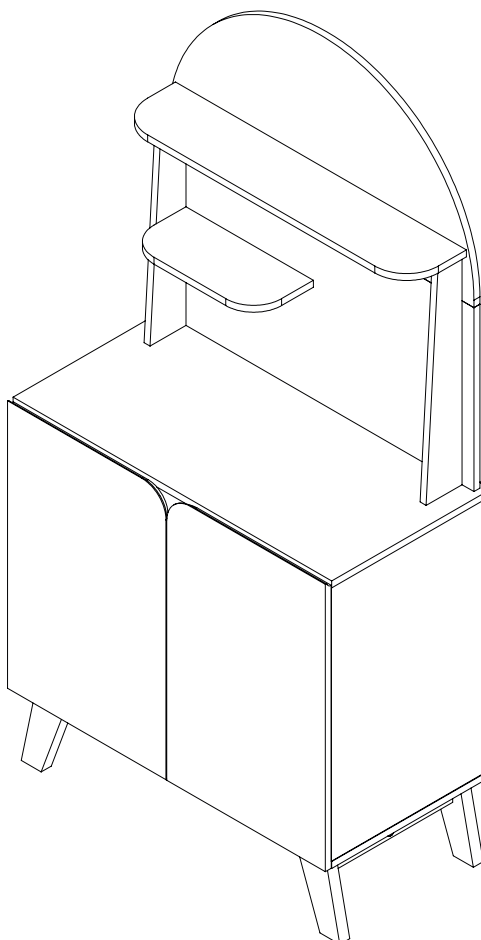

Parabéns, você montou seu móvel! Agora é só decorar sua casa e aproveitar!

Queremos ver como ficou o móvel Artely do seu jeito... Marque a gente com a #meuartely. Ficaremos felizes em compartilhar!

Ah, e se tiver qualquer dúvida, sugestão ou comentário, entra em contato com a gente pelo nosso site www.artely.com.br.

¡Congratulaciones, montaste tu mueble! ¡Ahora solo decora tu casa y disfruta!

Queremos ver este producto en tu hogar, a tu manera... Utilice #meuartely, ¡ficaremos encantados de compartir tu foto!

Si tienes alguna duda, sugerencia o comentario, contáctenos a través de nuestro sitio web www.artely.com.br.

Congratulations, you've assembled your new furniture! Decorate your home and enjoy!

We want to see how this product is in your home... Use #meuartely, we will be happy to share your picture!

If you have any doubt, suggestion or comment, get in touch with us through our website www.artely.com.br.