

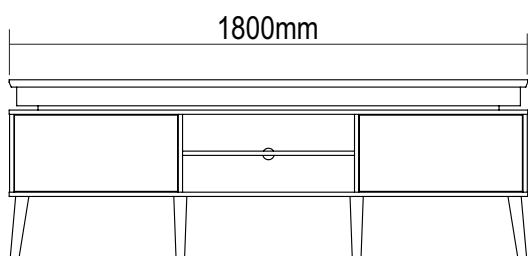

Rack Lumina II

Rack Lumina II / Lumina II Rack

Versão 1.0 / Versión 1.0 / 1.0 Version

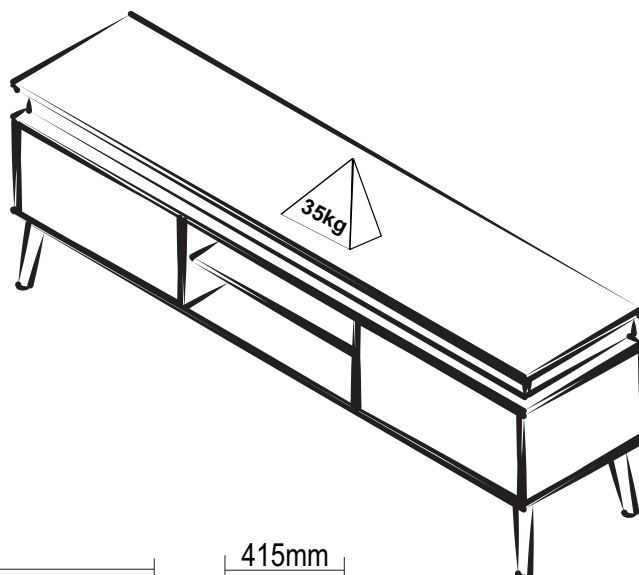

frente/frente/front

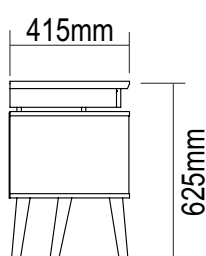

lateral/lado/side

Conservação e Limpeza - Conservación y Limpieza - Conservation and Cleaning

Não expor o produto ao sol, altas temperaturas e umidade. Não arrastar objetos sobre a superfície do móvel (ex.: TV, DVD, aparelho de som, objetos decorativos...) e manter em local seco e arejado. Para a limpeza, utilizar um pano seco e macio. Não é necessário o uso de materiais abrasivos ou álcool.

No exponga el producto a la luz solar, las altas temperaturas y la humedad. No arrastre los objetos a través de la superficie de la unidad (por ejemplo, TV, DVD, equipo de música, objetos de decoración ...) Mantener en un lugar fresco y seco. Para la limpieza, utilizar un paño seco y suave. El uso de materiales abrasivos o del alcohol no es necesario.

Do not expose the product to sunlight, high temperatures and humidity. Do not drag objects across the surface of the unit (TV, DVD, stereo, decorative objects ...) keep it in a cool dry place. For cleaning, use a dry and soft cloth. Do not use abrasive materials or alcohol.

Garantia

Este certificado de Garantia é uma vantagem adicional oferecida ao consumidor, porém para que o mesmo tenha validade é imprescindível que seja apresentada a NOTA FISCAL de compra do produto.

Com este produto, a Artely tem como objetivo atender plenamente o proprietário-consumidor, proporcionando a garantia na forma aqui estabelecida, pelo período de três meses a partir da data da nota fiscal de compra. A Artely restringe a sua responsabilidade à substituição gratuita das peças defeituosas, em caso de defeitos ou avarias devidamente constatados como sendo de fabricação, durante a vigência desta garantia.

A Artely declara a garantia nula e sem efeito se o produto for alterado, adulterado, molhado ou consertado e ainda pela prática de montagem inadequada ou mau uso. Também será considerada nula em casos de força maior, como aqueles causados por agentes da Natureza (chuvas, incêndios, excesso de umidade, cupins,...) e eventos externos como objetos arrastados sobre a superfície do móvel (ex.: TV, DVD, aparelho de som, objetos decorativos...).

Para exercer seus direitos de comprador é importante que antes de montar seu produto você leia com atenção as instruções de cada passo do manual de montagem que acompanha o móvel.

Caso o produto não esteja em conformidade, entre em contato com a loja onde efetuou a compra e faça sua reclamação, apontando os defeitos técnicos observados. Para agilizar o seu atendimento, tenha sempre em mãos o manual de montagem com os respectivos números das peças defeituosas, conforme descritas no manual.

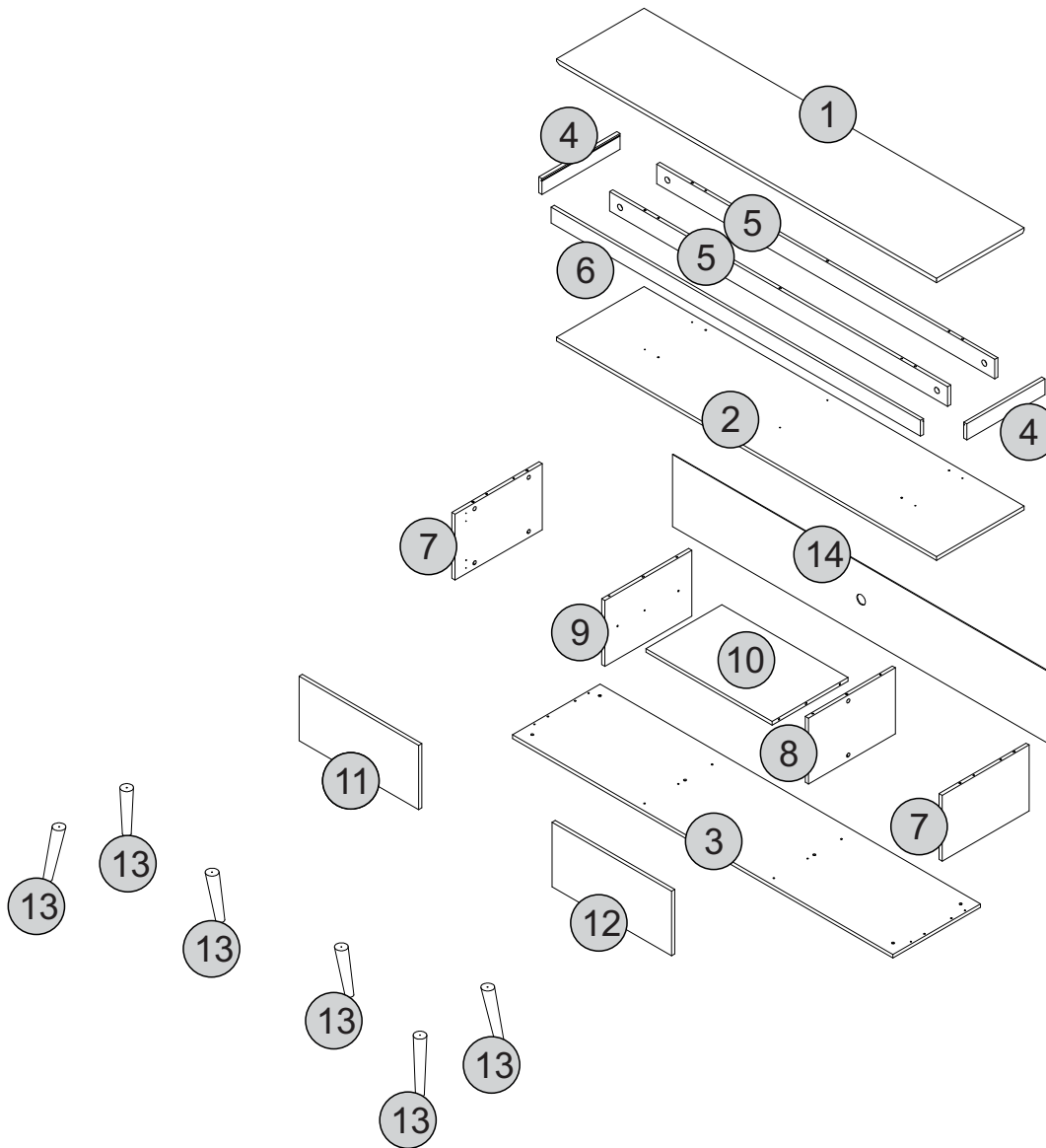
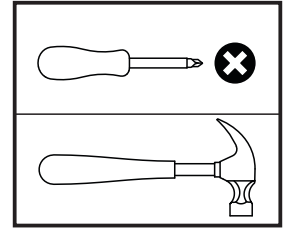







Descrição	Descripción	Description	Qty
1-Tampo (1800x415x25mm)	1-Tapa	1-Top	1
2-Tampo Intermediário (1800x415x15mm)	2-Parte Superior Media	2-Middle Top	1
3-Base (1800x415x15mm)	3-Base	3-Base	1
4-Travessa Lateral (370x65x15mm)	4-Travessano Lateral	4-Side Crossbeam	2
5-Travessa Central (1600x80x15mm)	5-Plato Central	5-Central Crossbeam	2
6-Travessa Frontal (1748x65x15mm)	6-Travessano Delantero	6-Front Crossbeam	1
7-Lateral (413x270x15mm)	7-Lado	7-Side	1
8-Divisão Direita (413x270x15mm)	8-División Derecho	8-Right Division	1
9-Divisão Esquerda (413x270x15mm)	9-División Izquierdo	9-Left Division	2
10-Prateleira (597x360x15mm)	10-Estante	10-Shelf	1
11-Porta Esquerda (566x264x15mm)	11-Puerta Izquierdo	11-Left Door	1
12-Porta Direita (566x264x15mm)	12-Puerta Derecha	12-Right Door	1
13-Pé (225x46x46mm)	13-Pie	13-Foot	6
14-Traseiro (1787x295x3mm)	14-Trasero	14-Back	1

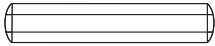
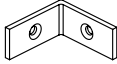
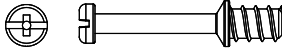

- O número na borda da peça corresponde ao manual.
- Para retirada do número usar Lustra-Móveis, Alcool em Gel ou Borracha.
-El número en el borde de la pieza coincide con el manual.
-Use una goma de borrar blanca, alcohol en gel o lustrador para muebles para eliminar los números.
-The number on the edge of the piece matches the manual.
-Use a White eraser, Alcohol Gel or Furniture Polish to remove the numbers.

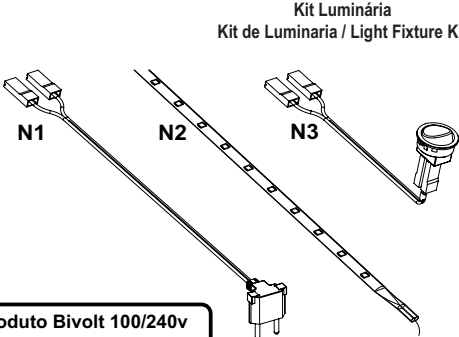
Lista de Materiais

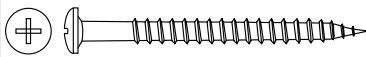
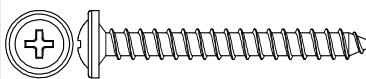
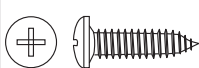
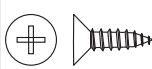
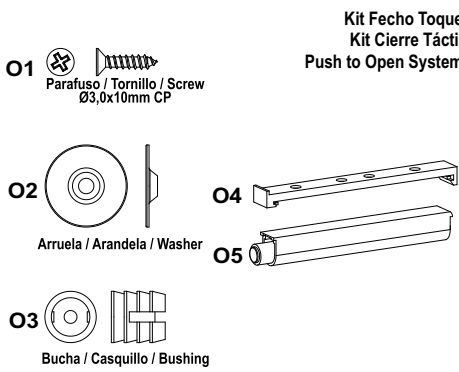
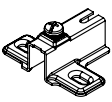
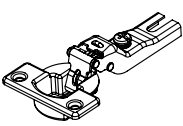
Lista de Materiales/ Hardware List

A		Cavilha / Tarugo / Dowel Ø6x30mm	28	L		Cantoneira / Cantonera / Corner Brace 25x25x13mm	02
B		Minifix / Minifix / Minifix Ø7x30mm	20	M		Suporte Angular Soporte Angular / Plastic Corner Brace	08
C		Tambor / Tambor / Minifix Cam Ø15x12mm	20	N		Kit Luminária Kit de Luminaria / Light Fixture Kit	01
D		Tapa furo adesivo / Adhesivo / Hole Cover Ø18mm	16				
E		Parafuso Tornillo / Screw Ø3,5x40mm CP	06				
F		Parafuso Tornillo / Screw Ø5,0x40mm	06				
G		Parafuso Tornillo / Screw Ø4,0x14mm CP	36				
H		Parafuso Tornillo / Screw Ø3,5x12mm CCR	02	O		Kit Fecho Toque Kit Cierre Táctil Push to Open System	02
I		Calço Dobradiça Cuna / Chock	04				
J		Dobradiça Bisagra / Hinge	04				
K		Prego Nail / Clavo 8x8	30				

DICAS PARA FIXAR MINIFIX

TIP TO FASTEN THE MINIFIX
PISTA PARA ARREGLAR EL MINIFIX

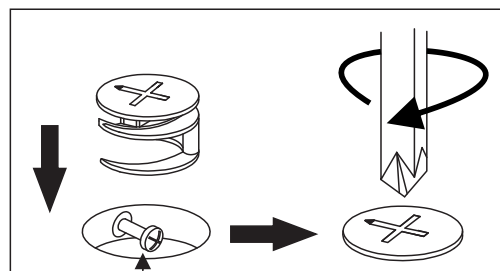

Cabeça do parafuso precisa estar no centro

La cabeza del tornillo debe estar en el centro

Screw head has to be in the center

Parafuso Minifix

Tornillo minifix/Minifix screw

Fixe o parafuso até o ressalto encostar na superfície da peça (veja o exemplo abaixo).

Tighten the screw until its overhang part lean on the piece surface (see the example below).

Fije el tornillo hasta que su parte sobresaliente toque la superficie de la pieza (vea el ejemplo abajo).

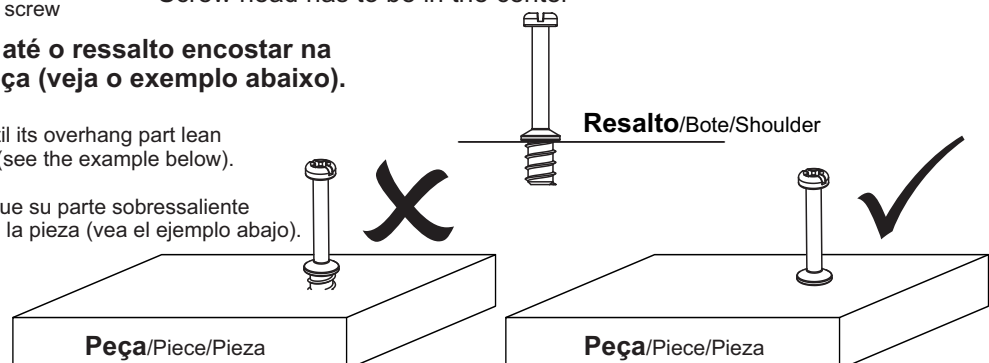

Passo 1

Paso/Step

PEÇA
Pieza/Piece

1 - TAMPO x1

FERRAGEM
Herraje/Hardware

B  06

FERRAMENTA
Herramienta/Tool

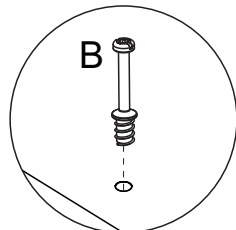
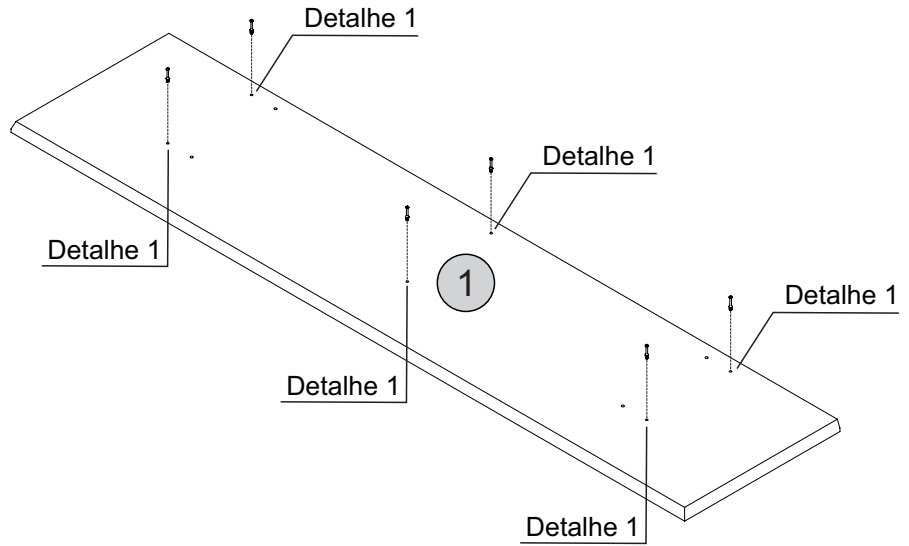
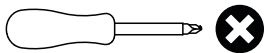

Detalhe 1
Detalle/Detail

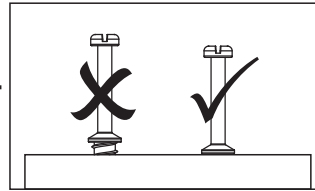

Passo 2

Paso/Step

PEÇA
Pieza/Piece

2 - TAMPO INTERMEDIÁRIO x1

FERRAGEM
Herraje/Hardware

B  06

H  06

O  02

O4 

O5 

FERRAMENTA
Herramienta/Tool

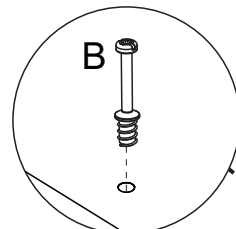
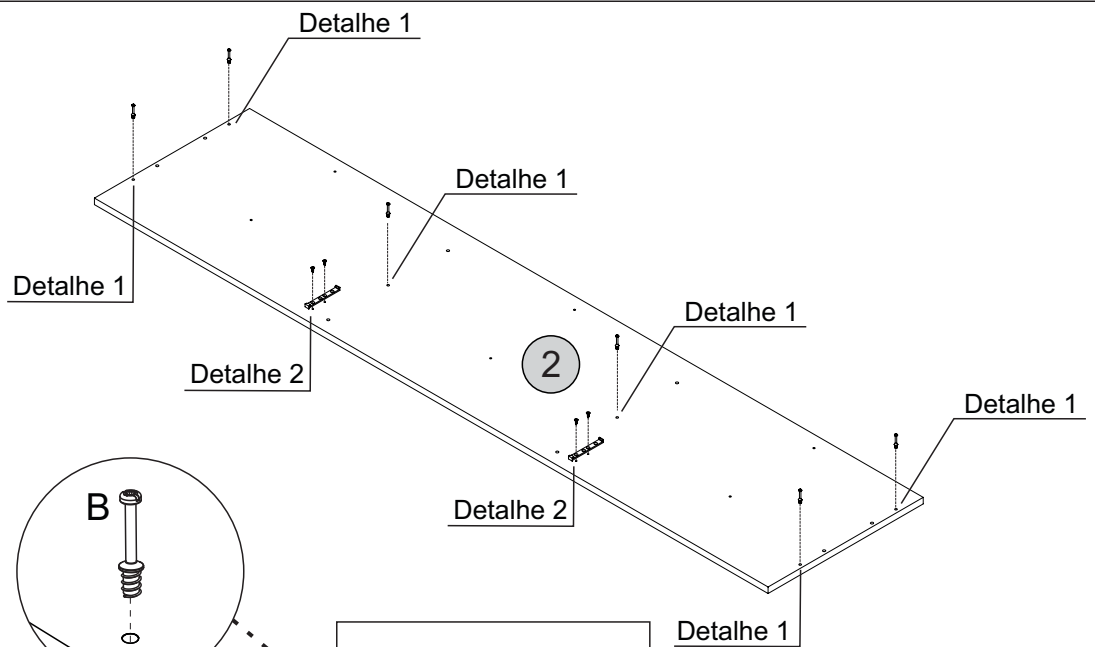
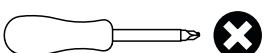

Detalhe 1
Detalle/Detail

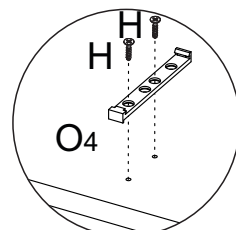
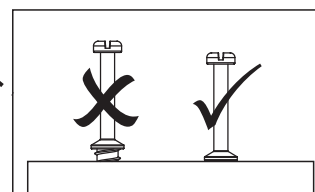

Detalhe 2
Detalle/Detail

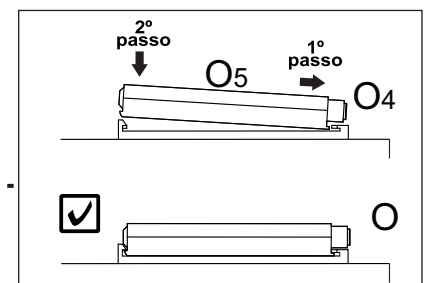

Detalhe 2
Detalle/Detail

Passo 3

Paso/Step

PEÇA

Pieza/Piece

7 - LATERAL x2

FERRAGEM

Herraje/Hardware

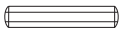
A  08

G  08

I  04

FERRAMENTA

Herramienta/Tool

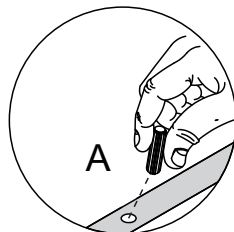
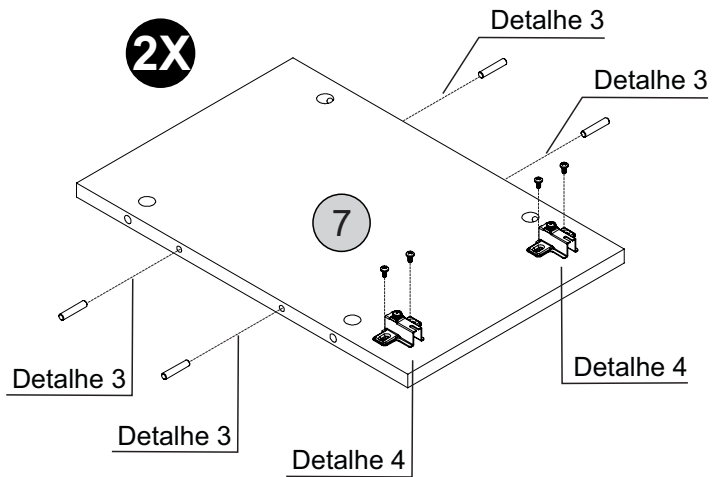
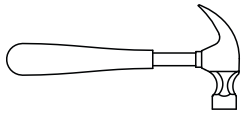
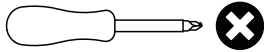

Detalhe 3
Detalle/Detail

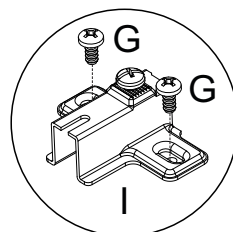

Detalhe 4
Detalle/Detail

Passo 4

Paso/Step

PEÇA

Pieza/Piece

8 - DIVISÃO DIREITA x1

FERRAGEM

Herraje/Hardware

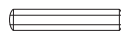
A  04

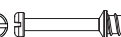
B  01

FERRAMENTA

Herramienta/Tool

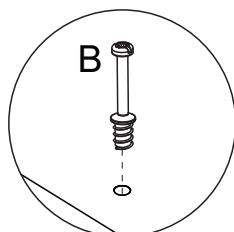
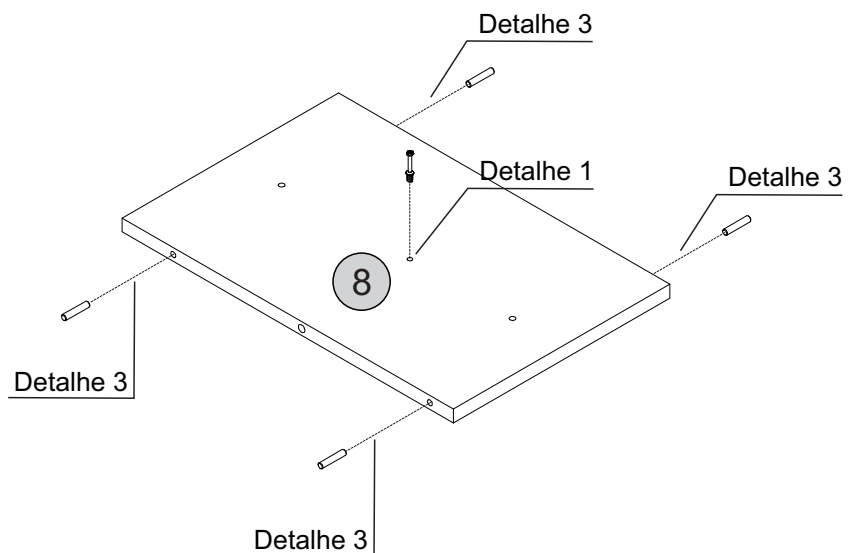
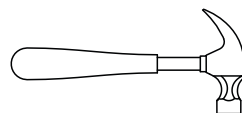
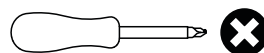

Detalhe 1
Detalle/Detail

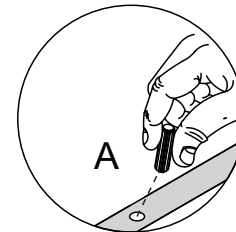
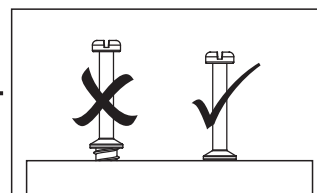

Detalhe 3
Detalle/Detail

Passo 5

Paso/Step

PEÇA
Pieza/Piece

9 - DIVISÃO ESQUERDA x1

FERRAGEM
Herraje/Hardware

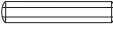
A  04

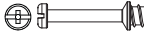
B  01

FERRAMENTA
Herramienta/Tool

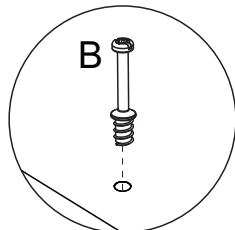
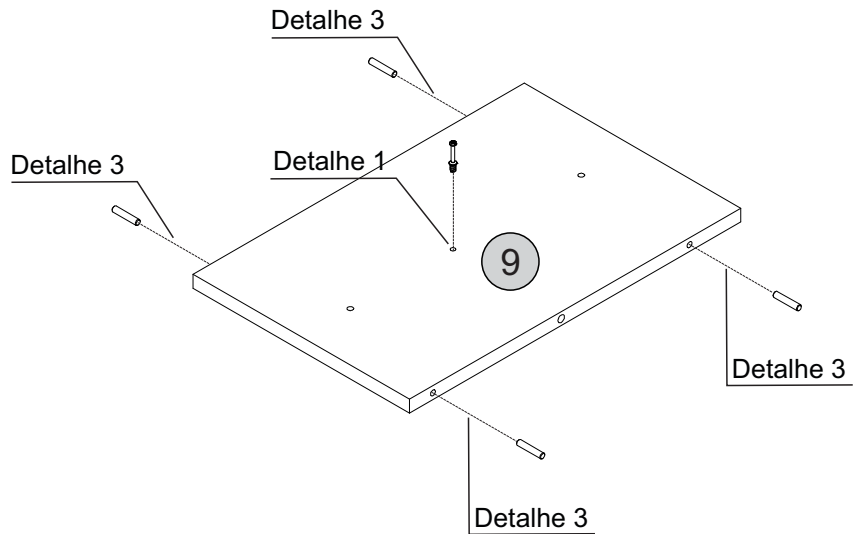
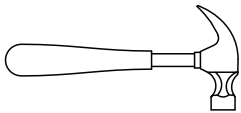
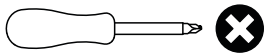

Detalhe 1
Detalle/Detail

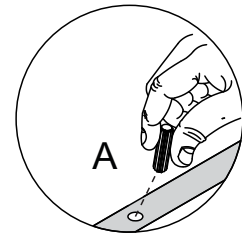
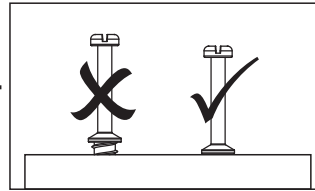

Detalhe 3
Detalle/Detail

Passo 6

Paso/Step

PEÇA
Pieza/Piece

5 - TRAVESSA CENTRAL x2

FERRAGEM
Herraje/Hardware

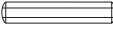
A  08

FERRAMENTA
Herramienta/Tool

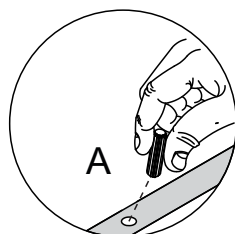
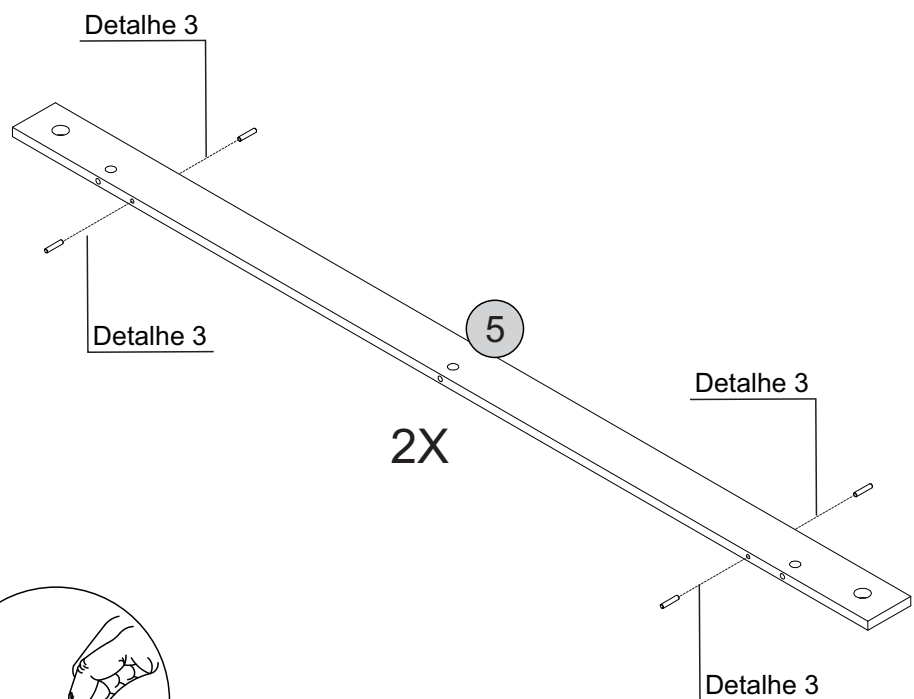
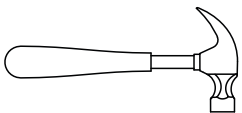

Detalhe 3
Detalle/Detail

Passo 7

Paso/Step

PEÇA
Pieza/Piece

10 - PRATELEIRA x1

FERRAGEM
Herraje/Hardware

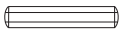
A  04

FERRAMENTA
Herramienta/Tool

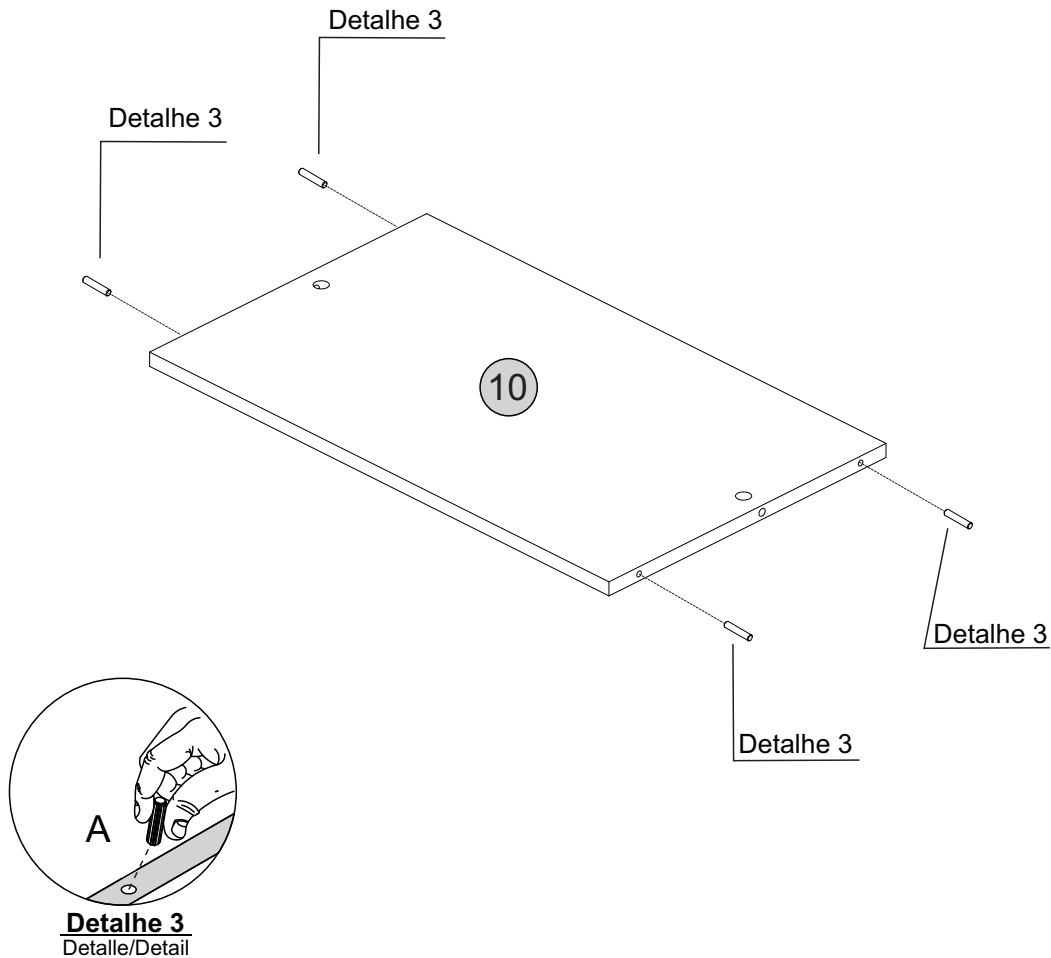
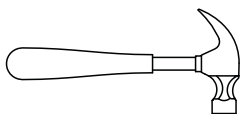

Passo 8

Paso/Step

PEÇA
Pieza/Piece

3 - BASE x1

FERRAGEM
Herraje/Hardware

B  06

FERRAMENTA
Herramienta/Tool

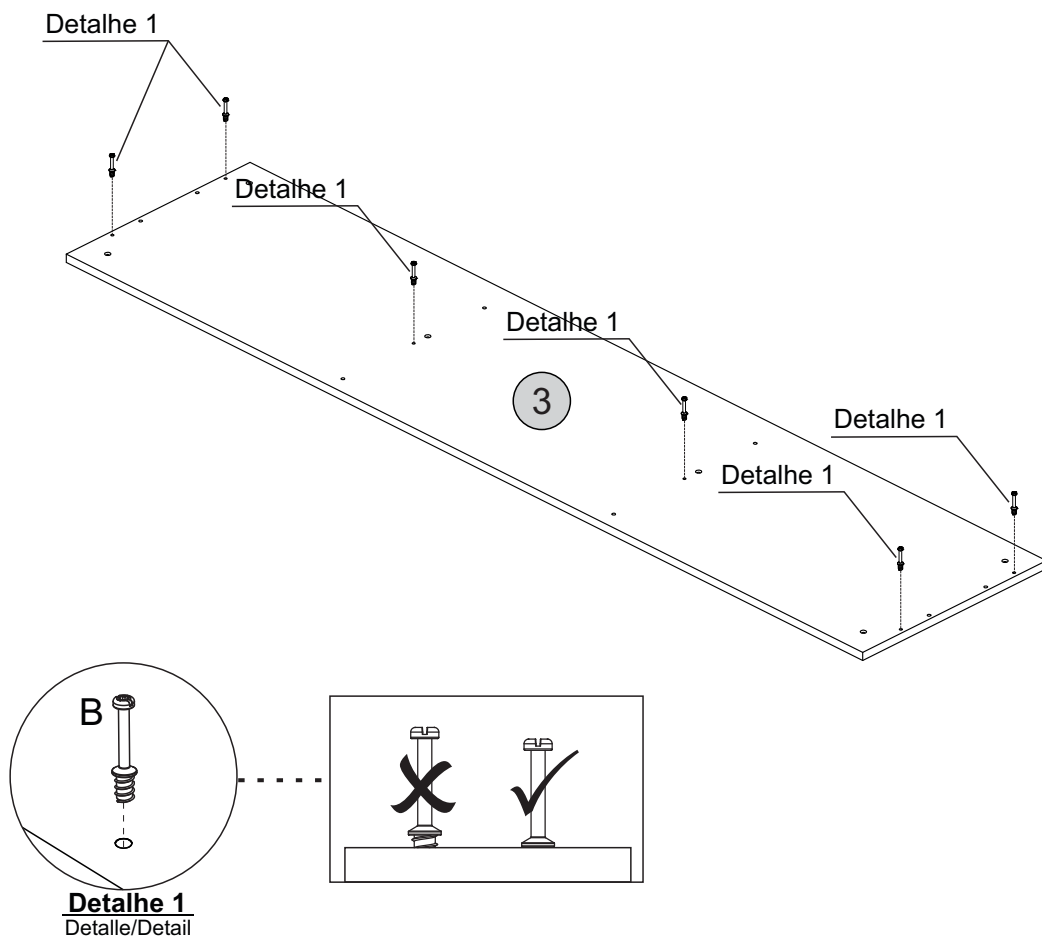
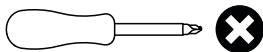

Passo 9

Paso/Step

PEÇA

Pieza/Piece

3 - BASE x1

13 - PÉ x6

FERRAGEM

Herraje/Hardware

D  04

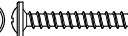
F  06

FERRAMENTA

Herramienta/Tool

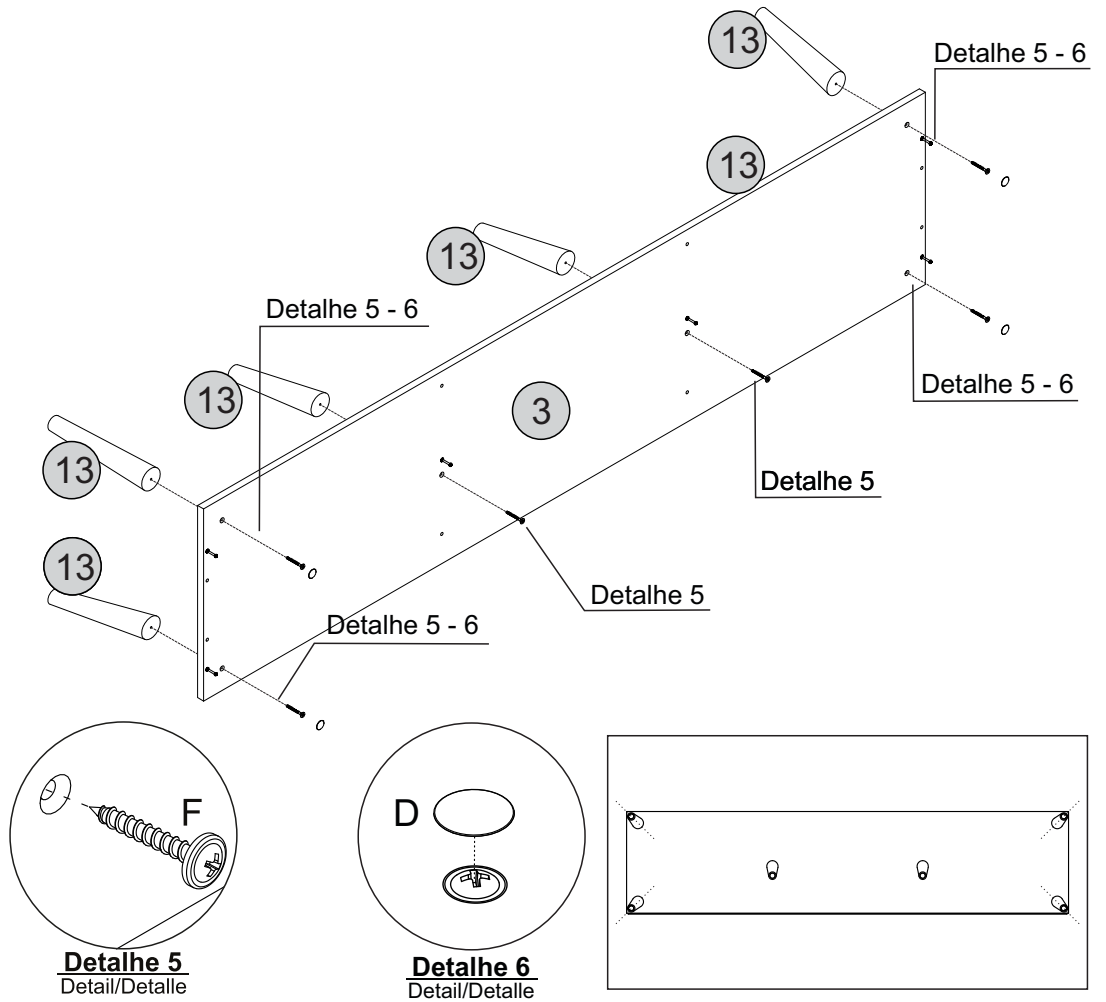
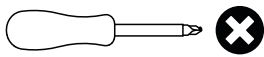

Passo 10

Paso/Step

PEÇA

Pieza/Piece

8 - DIVISÃO DIREITA x1

9 - DIVISÃO ESQUERDA x1

10 - PRATELEIRA x1

FERRAGEM

Herraje/Hardware

C   02

FERRAMENTA

Herramienta/Tool

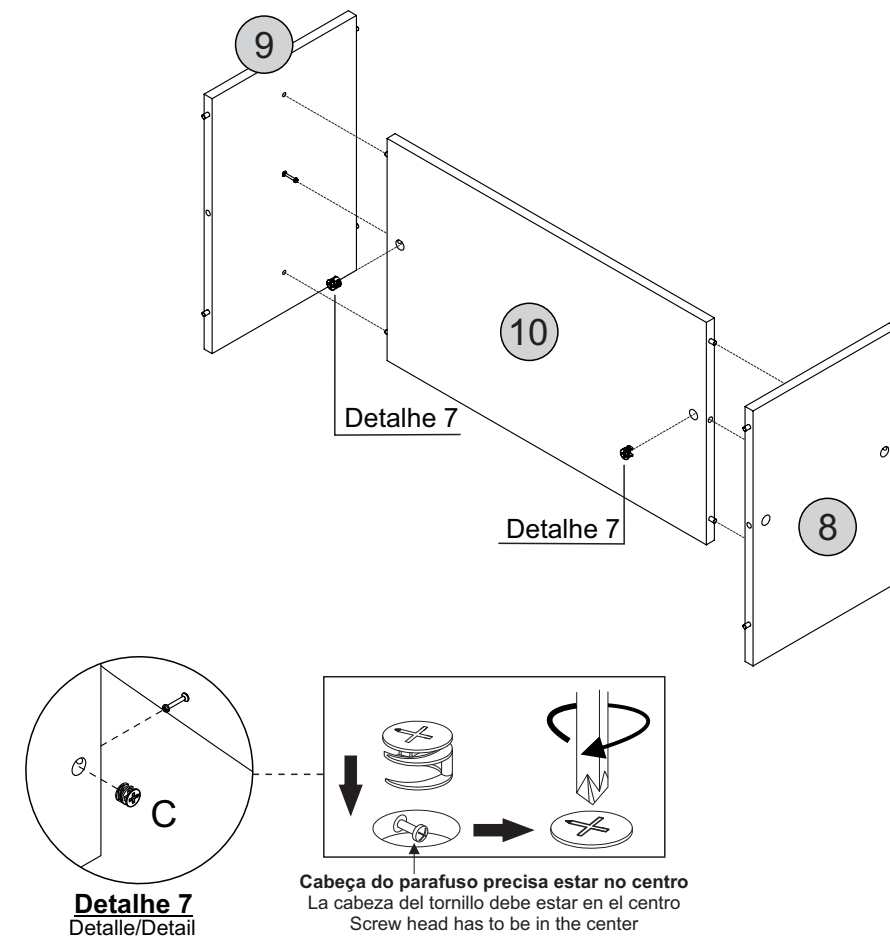
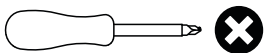

Passo 11

Paso/Step

PEÇA
Pieza/Piece

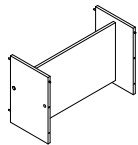
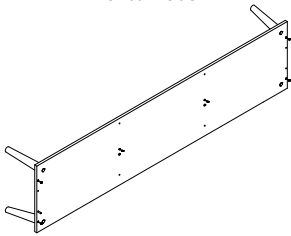

FERRAGEM
Herraje/Hardware

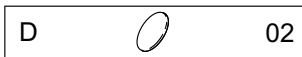
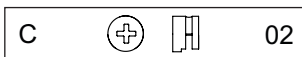

FERRAMENTA
Herramienta/Tool

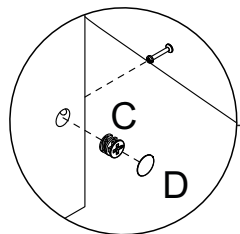
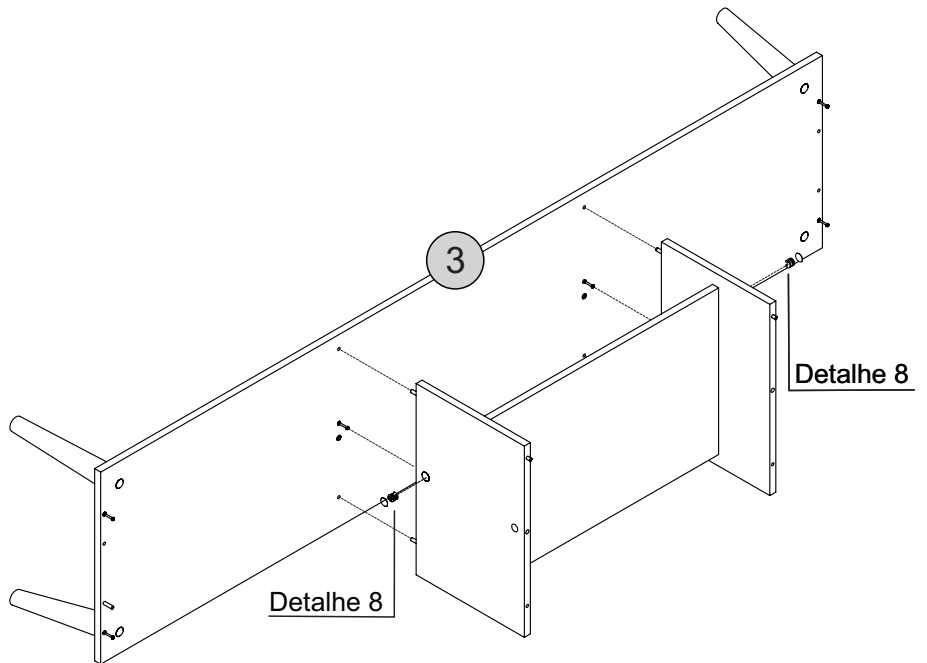
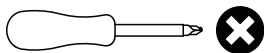

Detalhe 8
Detalle/Detail

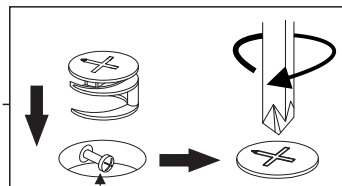

Cabeça do parafuso precisa estar no centro
La cabeza del tornillo debe estar en el centro
Screw head has to be in the center

Passo 12

Paso/Step

PEÇA
Pieza/Piece

7 - LATERAL x1

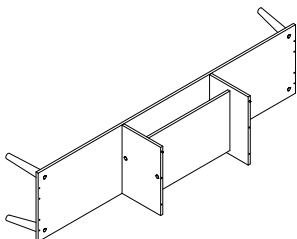

FERRAGEM
Herraje/Hardware

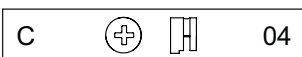

FERRAMENTA
Herramienta/Tool

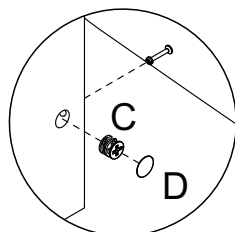
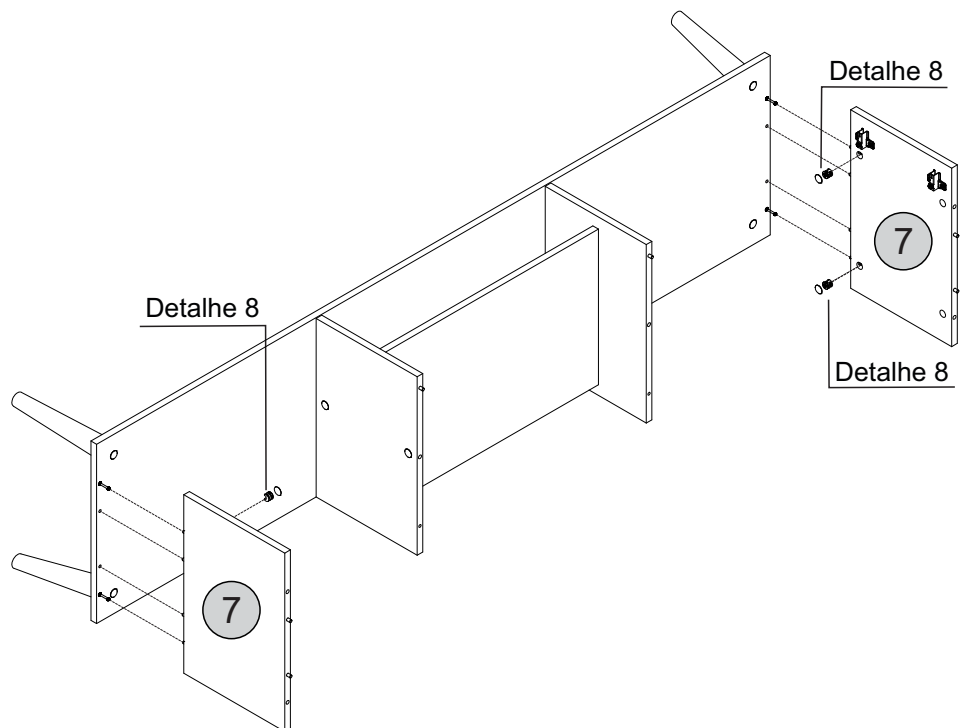
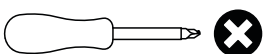

Detalhe 8
Detalle/Detail

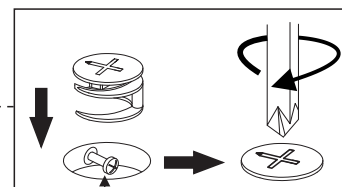

Cabeça do parafuso precisa estar no centro
La cabeza del tornillo debe estar en el centro
Screw head has to be in the center

Passo 13

Paso/Step

PEÇA
Pieza/Piece

4 - TRAVESSA LATERAL x2

6 - TRAVESSA FRONTAL x1

FERRAGEM
Herraje/Hardware

G  04

L  02

M  08

FERRAMENTA
Herramienta/Tool

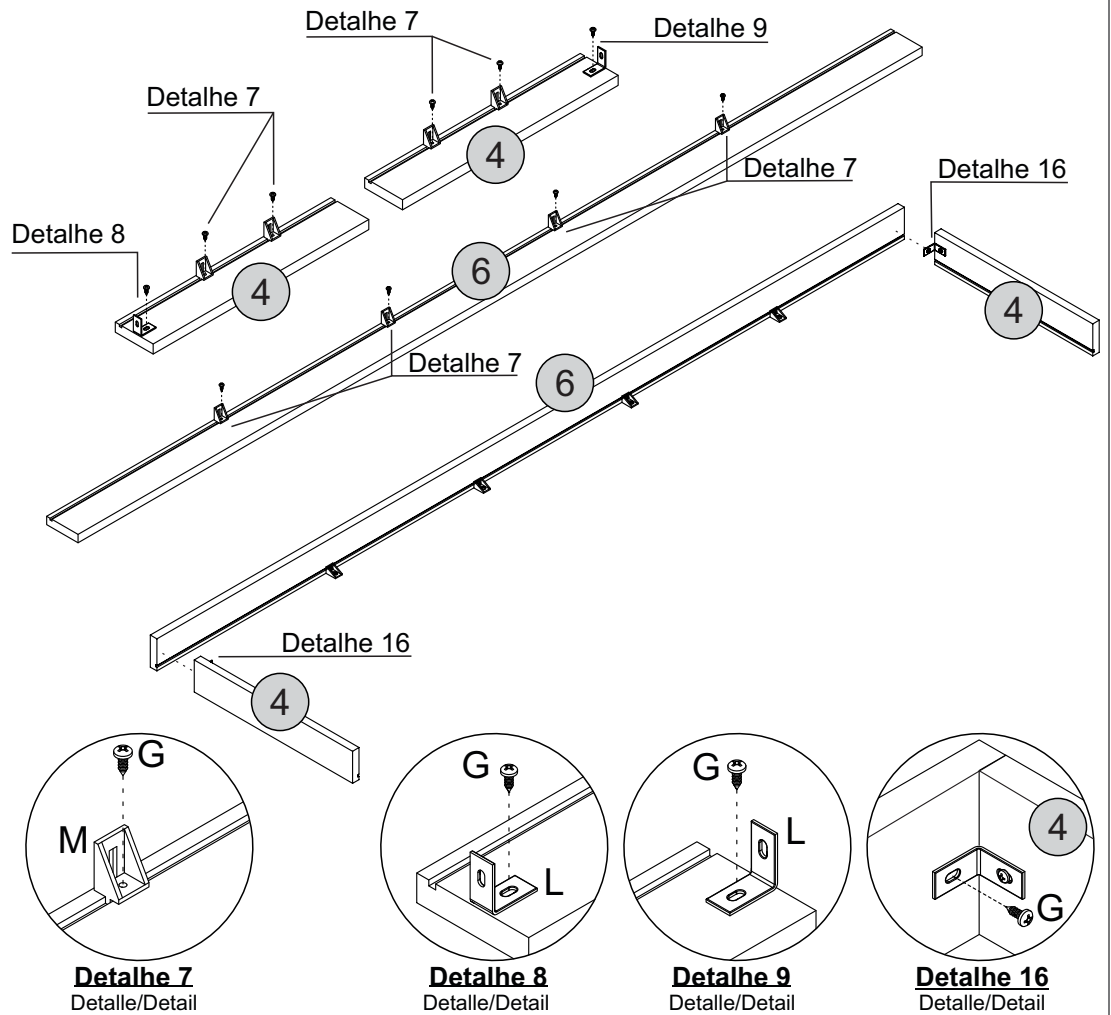
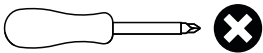

Passo 14

Paso/Step

PEÇA
Pieza/Piece

1 - TAMPO x1

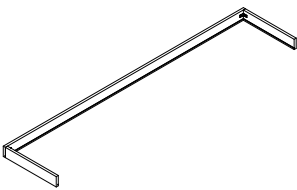

FERRAGEM
Herraje/Hardware

G  08

FERRAMENTA
Herramienta/Tool

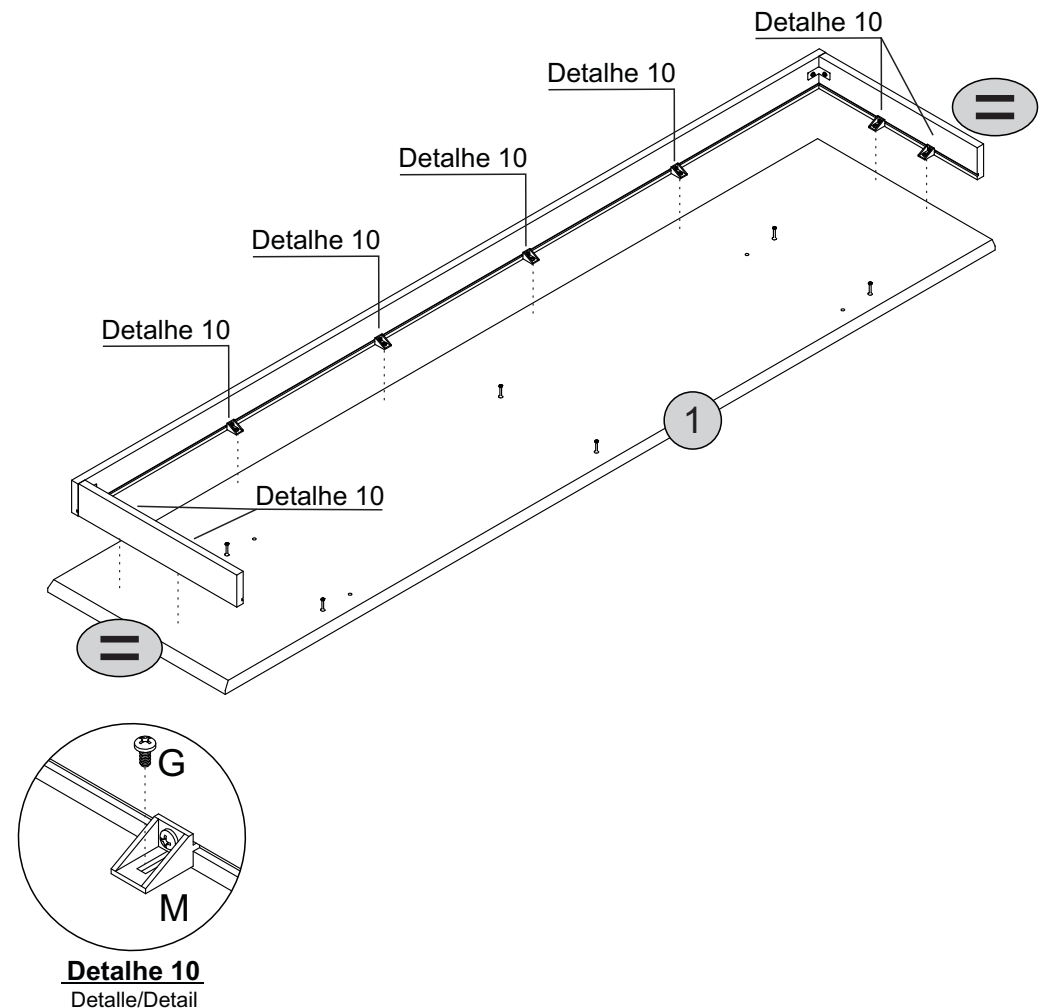
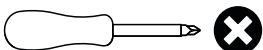

Passo 15



Paso/Step

PEÇA
Pieza/Piece

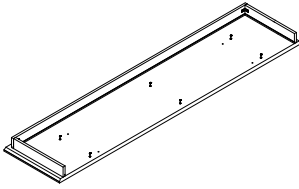
5 - TRAVESSA CENTRAL x1



FERRAGEM
Herraje/Hardware

C   06

FERRAMENTA
Herramienta/Tool

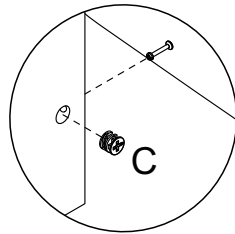
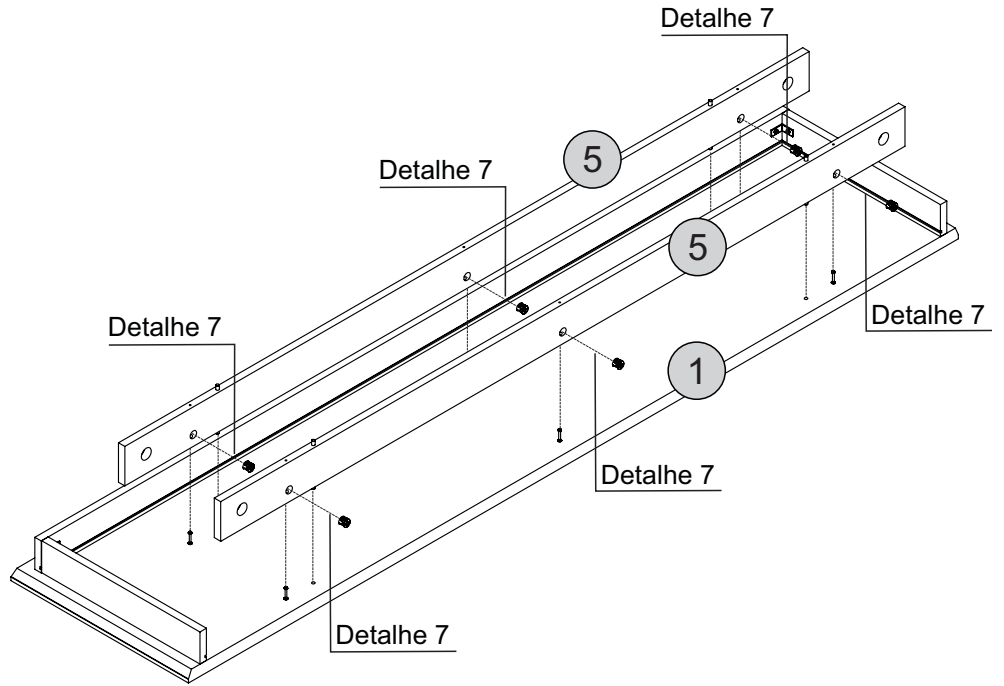
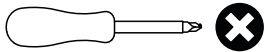

Detalhe 7
Detalle/Detail

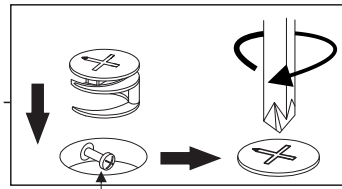

Cabeça do parafuso precisa estar no centro
La cabeza del tornillo debe estar en el centro
Screw head has to be in the center

Passo 16

Paso/Step

PEÇA
Pieza/Piece

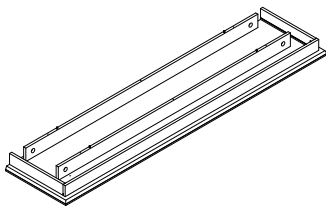

FERRAGEM
Herraje/Hardware

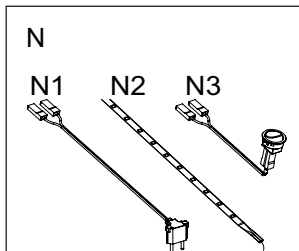

 **Produto Bivolt 100/240v**
Producto Bivolt 100/240v
Bivolt Product 100/240v

FERRAMENTA
Herramienta/Tool

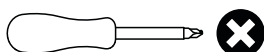

Atenção

- Para instalação verificar o manual que acompanha o Kit Luminária, antes de ligar na tomada.
- Consulte el manual que viene con el kit de Luminaria antes de enchufarlo.
- Check the manual that came with the Light Fixture Kit before plugging it in.

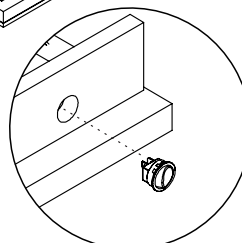
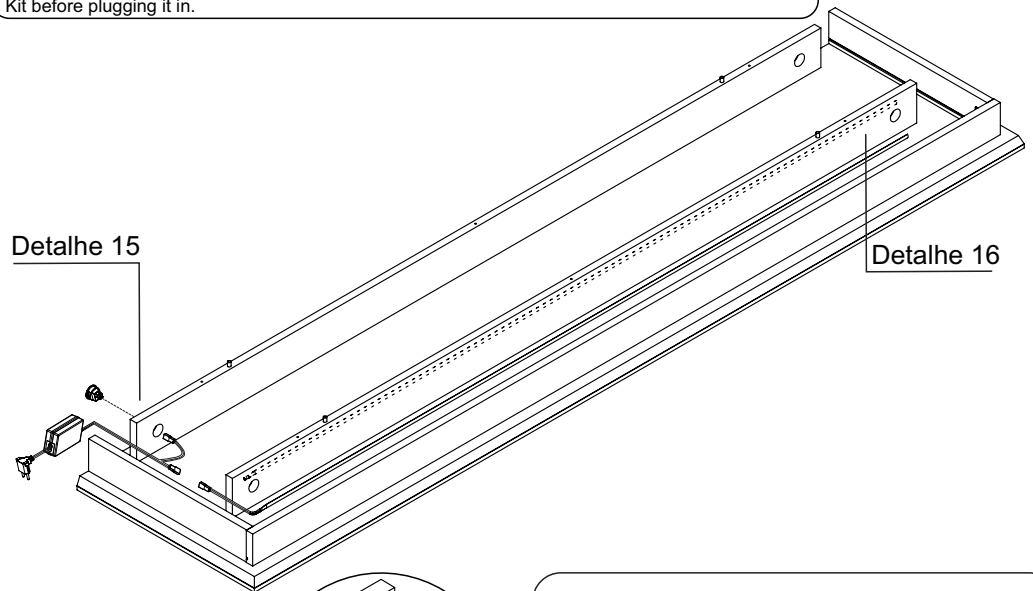

Detalhe 15
Detalle/Detail

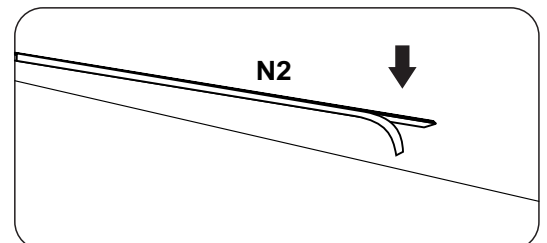

Detalhe 16
Detalle/Detail

Passo 17

Paso/Step

PEÇA
Pieza/Piece

3 - BASE x1

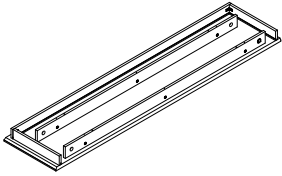

FERRAGEM
Herraje/Hardware

E  06

FERRAMENTA
Herramienta/Tool

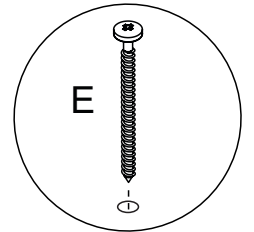
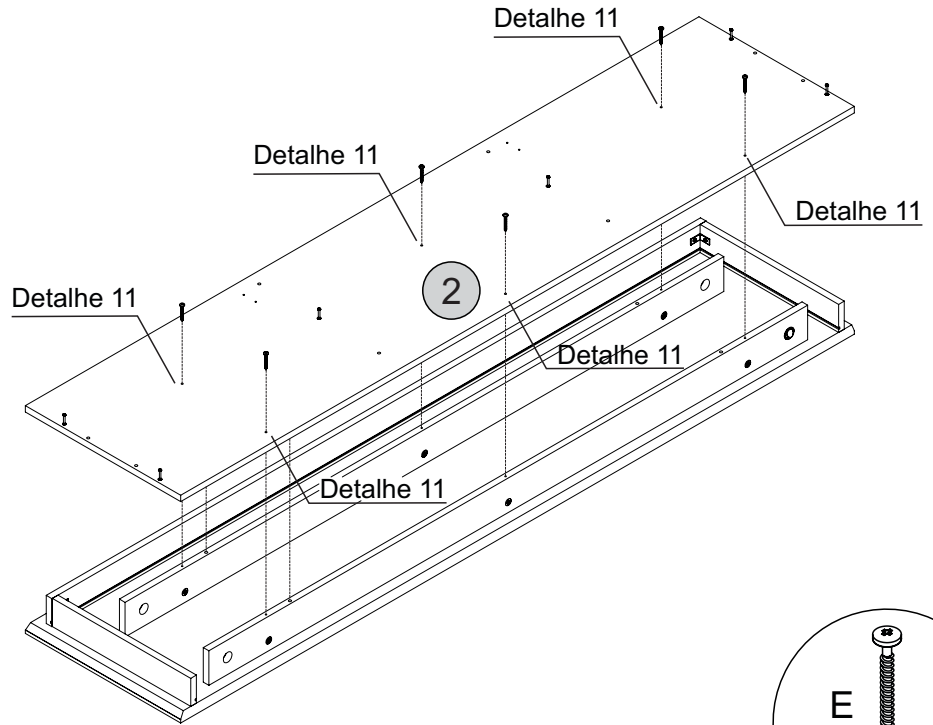
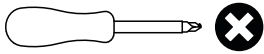

Detalhe 11
Detalle/Detail

Passo 18

Paso/Step

PEÇA
Pieza/Piece

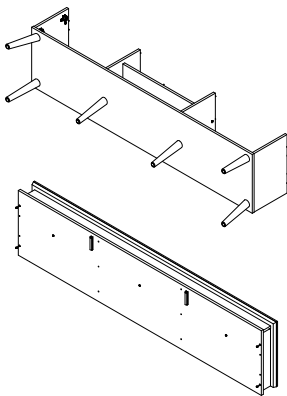

FERRAGEM
Herraje/Hardware

C   06

D  06

FERRAMENTA
Herramienta/Tool

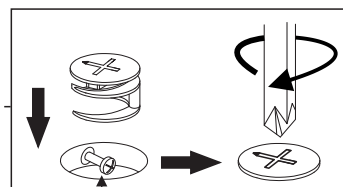
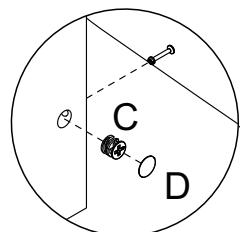
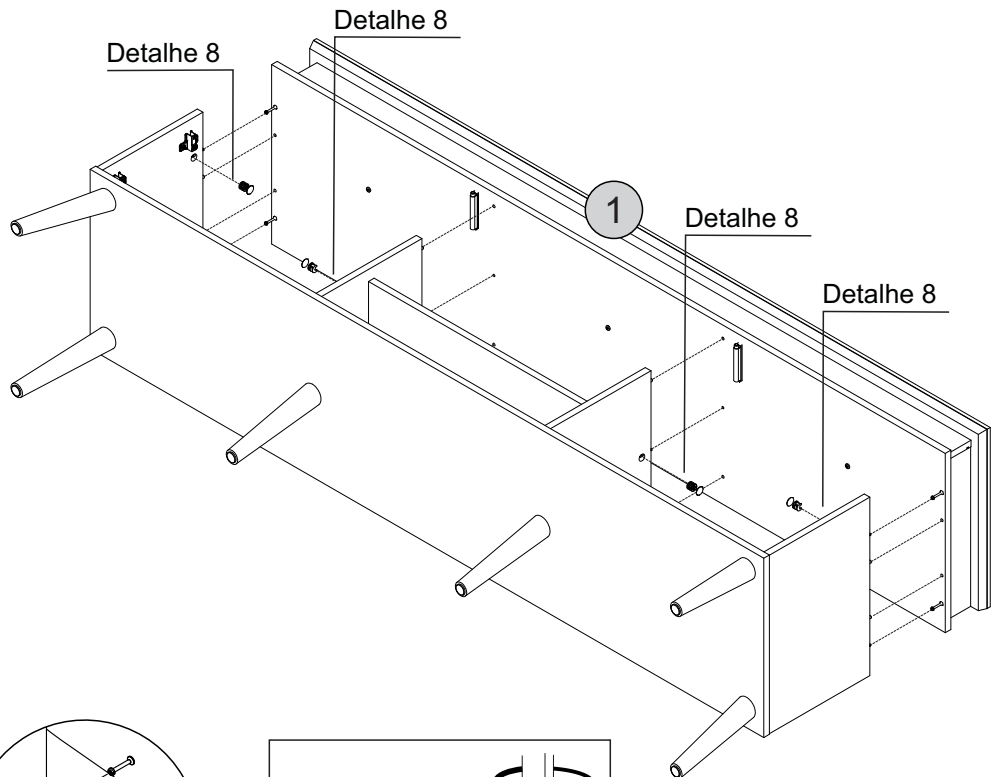
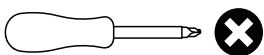

Cabeça do parafuso precisa estar no centro
La cabeza del tornillo debe estar en el centro
Screw head has to be in the center

Detalhe 8
Detalle/Detail

Passo 19

Paso/Step

PEÇA
Pieza/Piece

14 - TRASEIRO x1

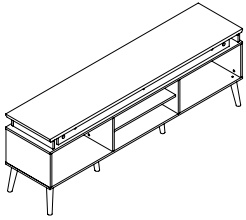

FERRAGEM
Herraje/Hardware

K  30

FERRAMENTA
Herramienta/Tool

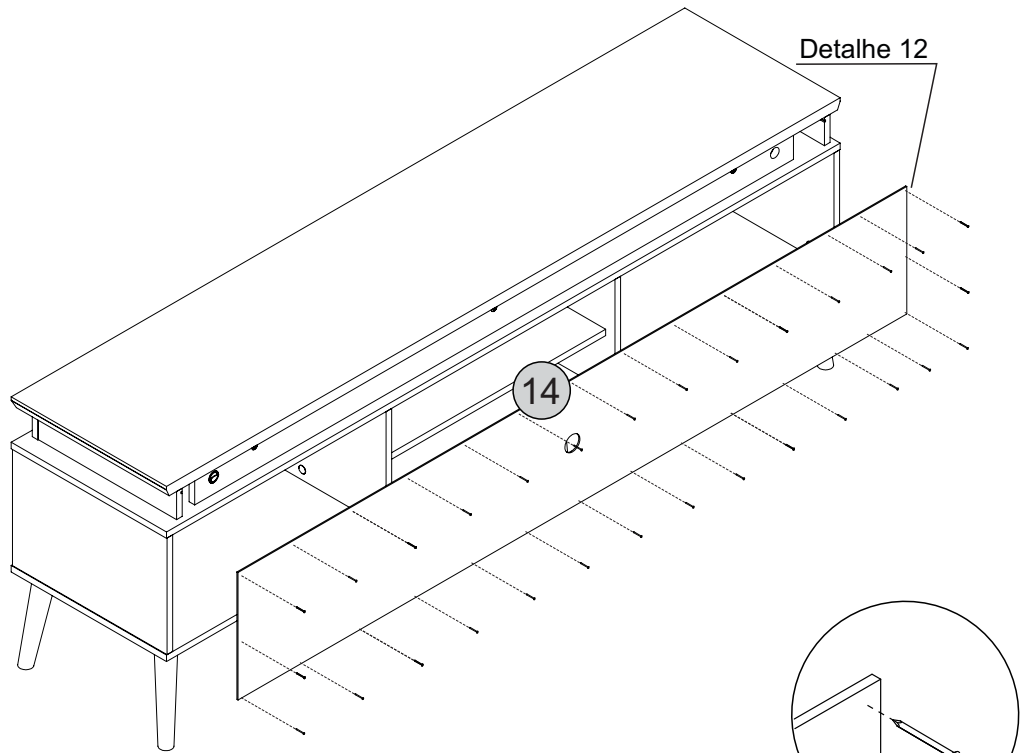
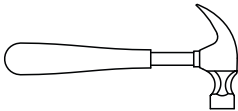

Detalhe 12
Detalle/Detail

Passo 20

Paso/Step

PEÇA
Pieza/Piece

11 - PORTA ESQUERDA x1

12 - PORTA DIREITA x1

FERRAGEM
Herraje/Hardware

G  08

J  04

O  02

O2  03

FERRAMENTA
Herramienta/Tool

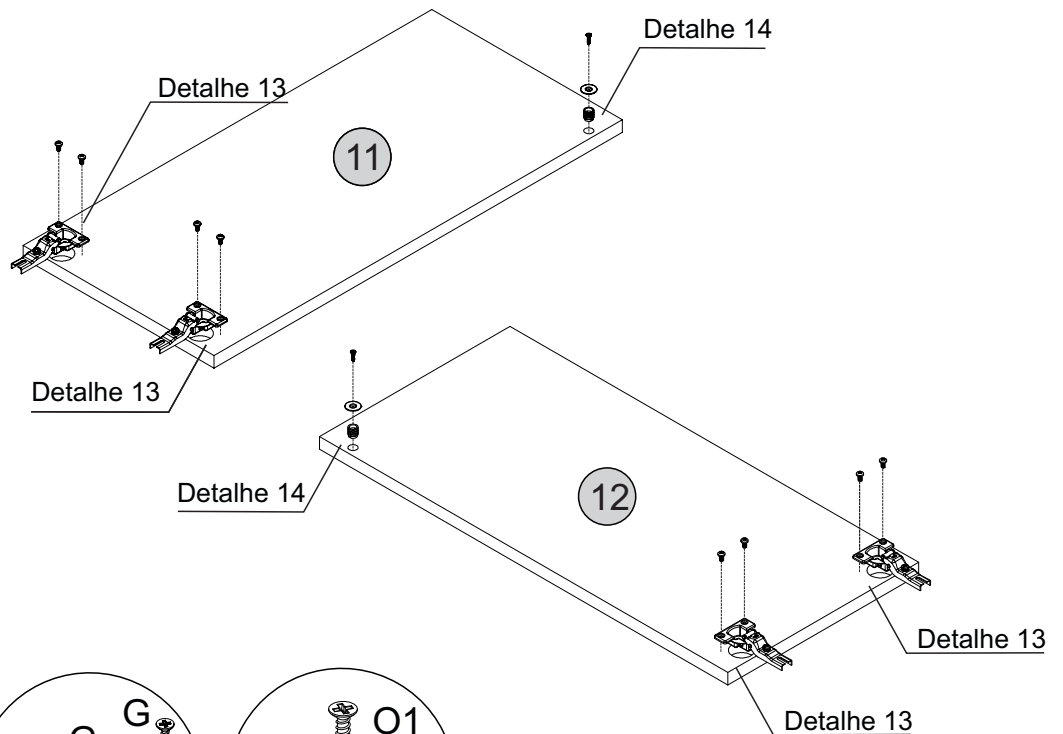
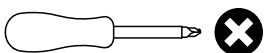

Detalhe 13
Detalle/Detail

Detalhe 14
Detalle/Detail

Passo 21

Paso/Step

PEÇA
Pieza/Piece

11 - PORTA ESQUERDA x1

12 - PORTA DIREITA x1

FERRAGEM
Herraje/Hardware

FERRAMENTA
Herramienta/Tool

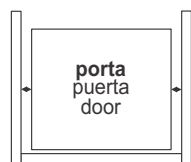
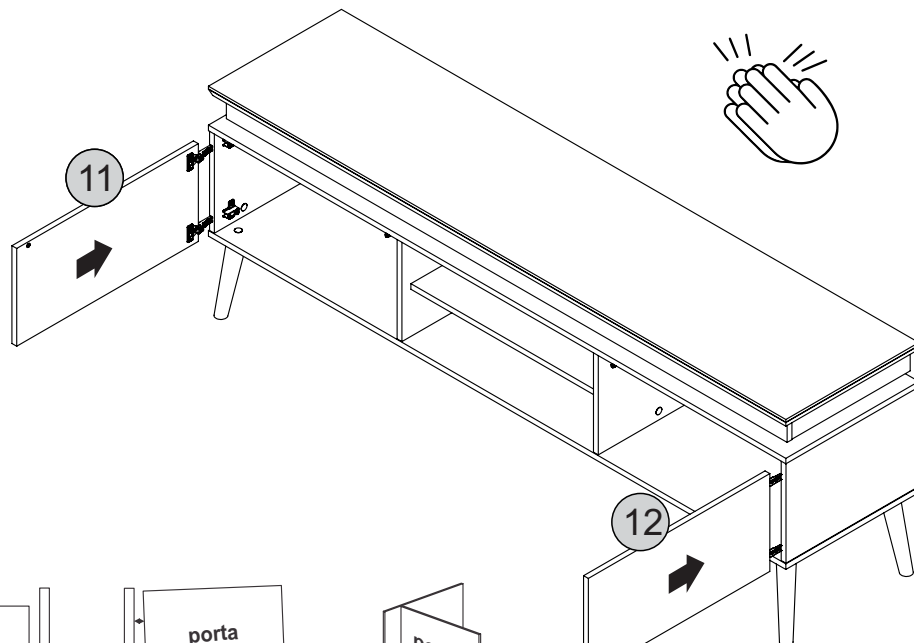
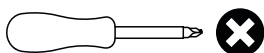

Ajuste de Largura
ajuste de ancho
width adjustment



Ajuste Interno
ajuste de ancho
Internal Adjustment



Ajuste de Profundidade
Ajuste de profundidad
Depth Adjustment

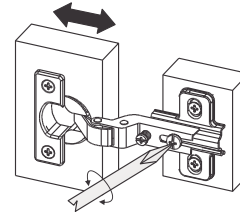
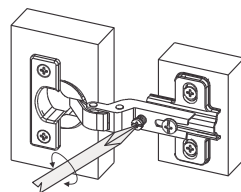
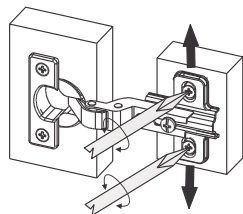

Parabéns, você montou seu móvel! Agora é só decorar sua casa e aproveitar!

Queremos ver como ficou o móvel Artely do seu jeito... Marque a gente com a #meuartely. Ficaremos felizes em compartilhar!

Ah, e se tiver qualquer dúvida, sugestão ou comentário, entra em contato com a gente pelo nosso site www.artely.com.br.

¡Congratulaciones, montaste tu mueble! ¡Ahora solo decora tu casa y disfruta!

Queremos ver este producto en tu hogar, a tu manera... Utilice #meuartely, ¡ficaremos encantados de compartir tu foto!

Si tienes alguna duda, sugerencia o comentario, contáctenos a través de nuestro sitio web www.artely.com.br.

Congratulations, you've assembled your new furniture! Decorate your home and enjoy!

We want to see how this product is in your home... Use #meuartely, we will be happy to share your picture!

If you have any doubt, suggestion or comment, get in touch with us througho our website www.artely.com.br