

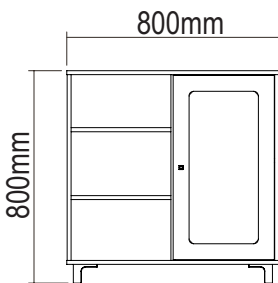

Buffet Charlotte

Buffet Elegance / Elegance Buffet

Versão 1.0 / Versión 1.0 / Version 1.0

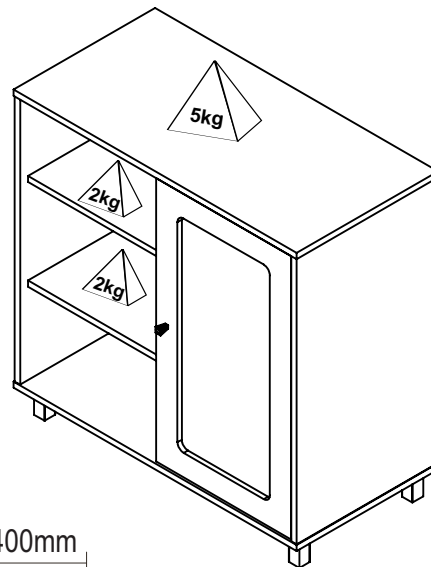

frente/frente/front

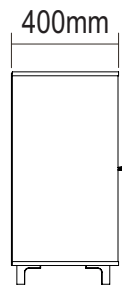

lateral/lado/side

Conservação e Limpeza - Conservación y Limpieza - Conservation and Cleaning

Não expor o produto ao sol, altas temperaturas e umidade. Não arrastar objetos sobre a superfície do móvel (ex.: TV, DVD, aparelho de som, objetos decorativos...) e manter em local seco e arejado. Para a limpeza, utilizar um pano seco e macio. Não é necessário o uso de materiais abrasivos ou álcool.

No exponga el producto a la luz solar, las altas temperaturas y la humedad. No arrastre los objetos a través de la superficie de la unidad (por ejemplo, TV, DVD, equipo de música, objetos de decoración ...) Mantener en un lugar fresco y seco. Para la limpieza, utilizar un paño seco y suave. El uso de materiales abrasivos o del alcohol no es necesario.

Do not expose the product to sunlight, high temperatures and humidity. Do not drag objects across the surface of the unit (TV, DVD, stereo, decorative objects ...) keep it in a cool dry place. For cleaning, use a dry and soft cloth. Do not use abrasive materials or alcohol.

Garantia

Este certificado de Garantia é uma vantagem adicional oferecida ao consumidor, porém para que o mesmo tenha validade é imprescindível que seja apresentada a NOTA FISCAL de compra do produto.

Com este produto, a Artely tem como objetivo atender plenamente o proprietário-consumidor, proporcionando a garantia na forma aqui estabelecida, pelo período de três meses a partir da data da nota fiscal de compra. A Artely restringe a sua responsabilidade à substituição gratuita das peças defeituosas, em caso de defeitos ou avarias devidamente constatados como sendo de fabricação, durante a vigência desta garantia.

A Artely declara a garantia nula e sem efeito se o produto for alterado, adulterado, molhado ou consertado e ainda pela prática de montagem inadequada ou mau uso. Também será considerada nula em casos de força maior, como aqueles causados por agentes da Natureza (chuvas, incêndios, excesso de umidade, cupins,...) e eventos externos como objetos arrastados sobre a superfície do móvel (ex.: TV, DVD, aparelho de som, objetos decorativos...).

Para exercer seus direitos de comprador é importante que antes de montar seu produto você leia com atenção as instruções de cada passo do manual de montagem que acompanha o móvel.

Caso o produto não esteja em conformidade, entre em contato com a loja onde efetuou a compra e faça sua reclamação, apontando os defeitos técnicos observados. Para agilizar o seu atendimento, tenha sempre em mãos o manual de montagem com os respectivos números das peças defeituosas, conforme descritas no manual.

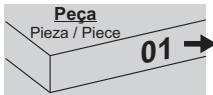



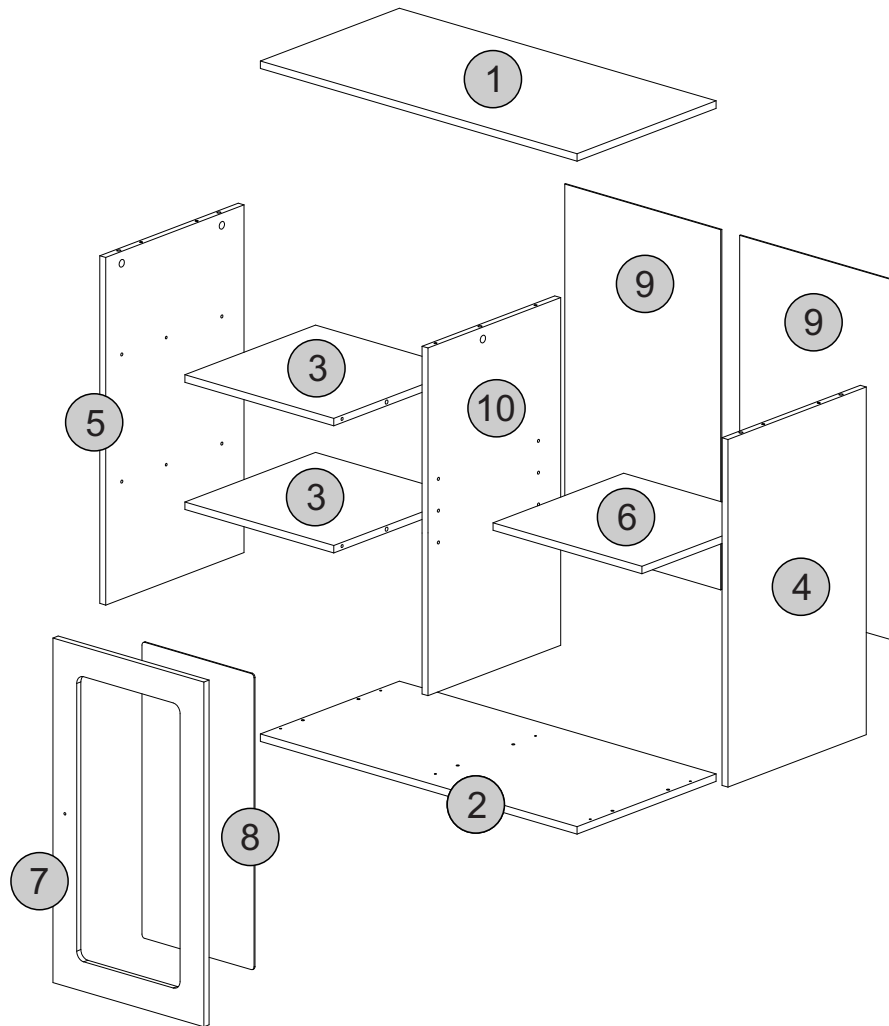
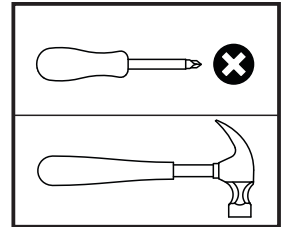





- O número na borda da peça corresponde ao manual.
- Para retirada do número usar Lustra-Móveis, Alcool em Gel ou Borracha.
- El número en el borde de la pieza coincide con el manual.
- Use una goma de borrar blanca, alcohol en gel o lustrador para muebles para eliminar los números.
- The number on the edge of the piece matches the manual.
- Use a White eraser, Alcohol Gel or Furniture Polish to remove the numbers.

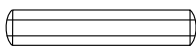
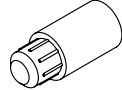
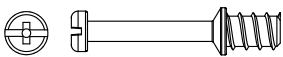
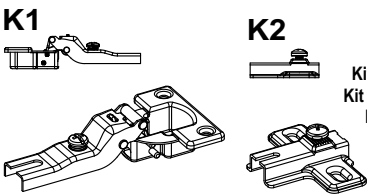
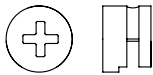
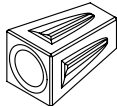

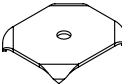
Descrição	Descripción	Description	Qty
1-Tampo (800x400x15mm)	1-Tapa	1-Top	1
2-Base (800x400x15mm)	2-Base	2-Base	1
3-Prateleira (376x376x15mm)	3-Anaqueil	3-Shelf	2
4-Lateral Direita (700x398x15mm)	4-Lado derecho	4-Right side	1
5-Lateral Esquerda (700x398x15mm)	5-Lado izquierdo	5-Left side	1
6-Prateleira Móvel (376x376x15mm)	6-Anaqueil movel	6-Móvil shelf	1
7-Porta (694x381x15mm)	7-Door	7-Puerta	1
8-Almofada/Aplique (596x283x3mm)	8-Almohadón/Aplicar	8-Cushion/Appliqué	1
9-Traseiro (725x394x3mm)	9-Rear	9-Trasero	2
10-Divisão (700x382x15mm)	10-Division	10-División	1

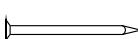
Lista de Materiais

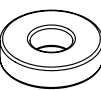
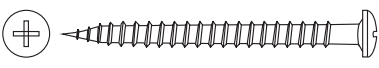
Lista de Materiales/ Hardware List

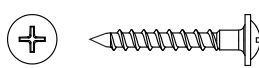
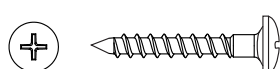
A		Cavilha / Tarugo / Dowel Ø6x30mm	20	J		Pino Sustentação Pasador de Apoio /Support Pin	04
B		Minifix / Minifix / Minifix Ø7x30mm	09	K		Kit Dobradiça Alta Kit de bisagras altas High Hinge Kit	02
C		Tambor / Tambor / Minifix Cam Ø15x12mm	09	M		Puxador / Arrancador / Puller /	01
D		Tapa furo adesivo / Adhesivo / Hole Cover Ø18mm	05	N		Prego / Clavo / Nail 8x8	06
E		Parafuso Tornillo / Screw Ø4x14mm CP	26	O		Prego / Clavo / Nail 8x8	26
F		Sapata Quadrada / Pata Cuadrada / Square Foot	04	P		Arruela / Aruela / Washer / 12x3	10
G		Parafuso / Tornillo / Screw / Ø3,5x40mm CP	06	Q		Produto Moldado / Silicona / Silicone Silicone	01
H		Parafuso / Tornillo / Screw / Ø3,5x25mm CF	01				
I		Parafuso / Tornillo / Screw / Ø4,0x30mm CP	04				

DICAS PARA FIXAR MINIFIX

TIP TO FASTEN THE MINIFIX
PISTA PARA ARREGLAR EL MINIFIX

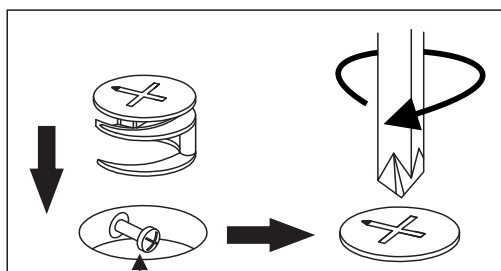

Cabeça do parafuso precisa estar no centro

La cabeza del tornillo debe estar en el centro
Screw head has to be in the center

Parafuso Minifix

Tornillo minifix/Minifix screw

Fixe o parafuso até o ressalto encostar na superfície da peça (veja o exemplo abaixo).

Tighten the screw until its overhang part lean on the piece surface (see the example below).

Fije el tornillo hasta que su parte sobresaliente toque la superficie de la pieza (vea el ejemplo abajo).

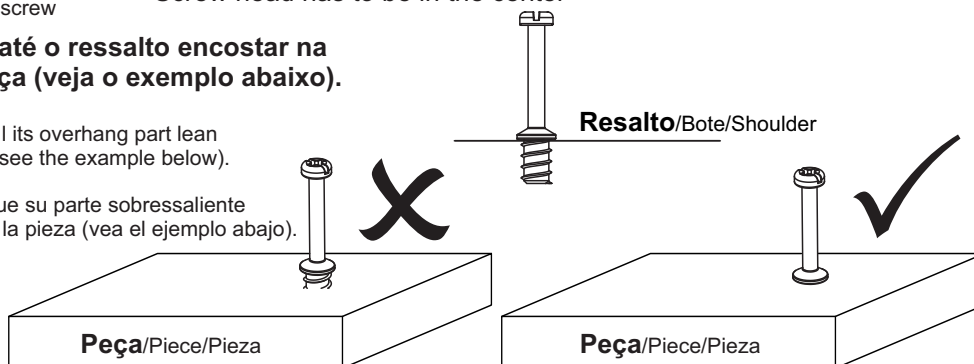

Passo 1

Paso/Step

PEÇA
Pieza/Piece

1 - TAMPO x1

FERRAGEM
Herraje/Hardware

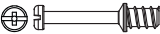
B  05

FERRAMENTA
Herramienta/Tool

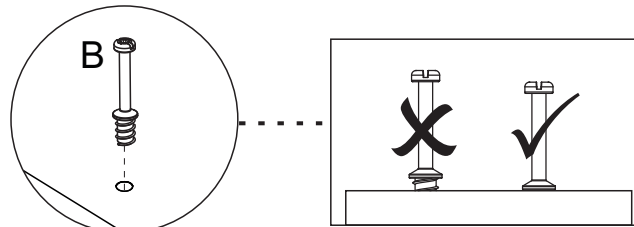
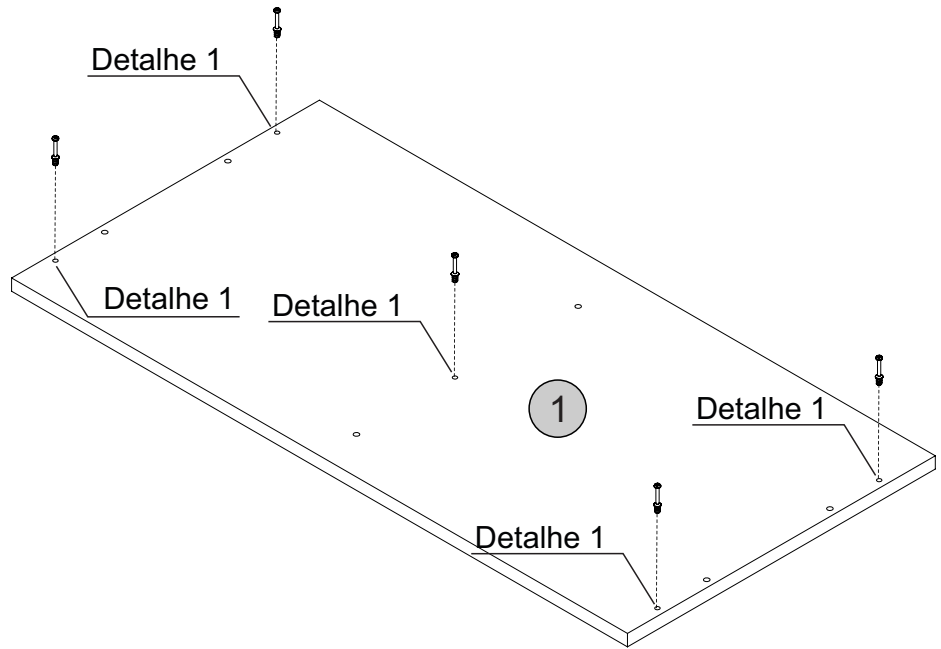
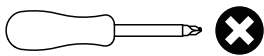

Detalhe 1
Detalle/Detail

Passo 2

Paso/Step

PEÇA
Pieza/Piece

3 - PRATELEIRA FIXA x2

FERRAGEM
Herraje/Hardware

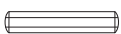
A  04

FERRAMENTA
Herramienta/Tool

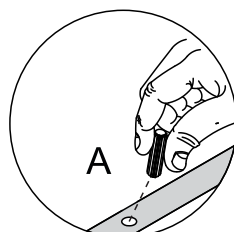
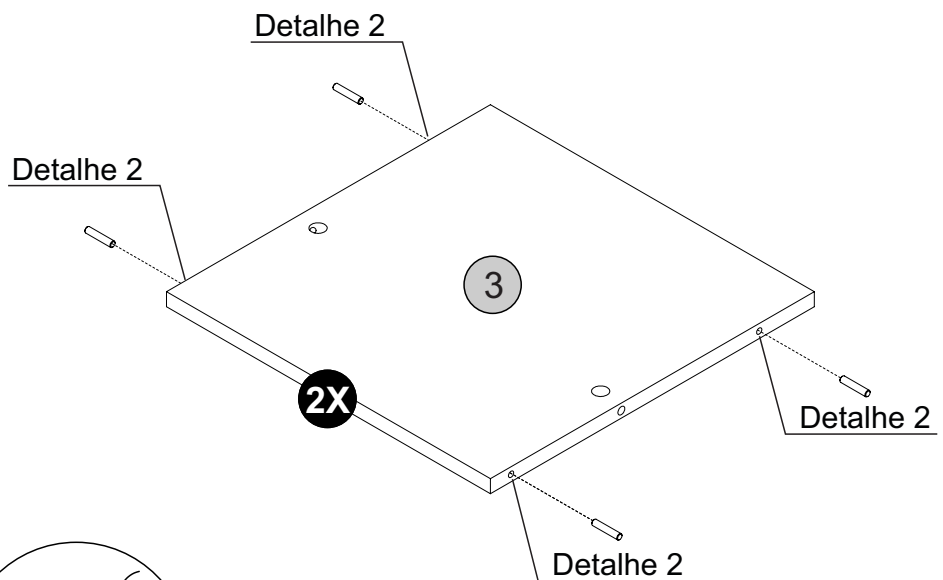
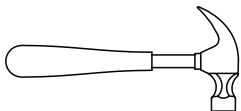

Detalhe 2
Detalle/Detail

Passo 3

Paso/Step

PEÇA
Pieza/Piece

4 - LATERAL DIREITA x1

FERRAGEM
Herraje/Hardware

A  04

E  04

J  02

K2  02

FERRAMENTA
Herramienta/Tool

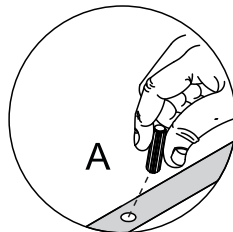
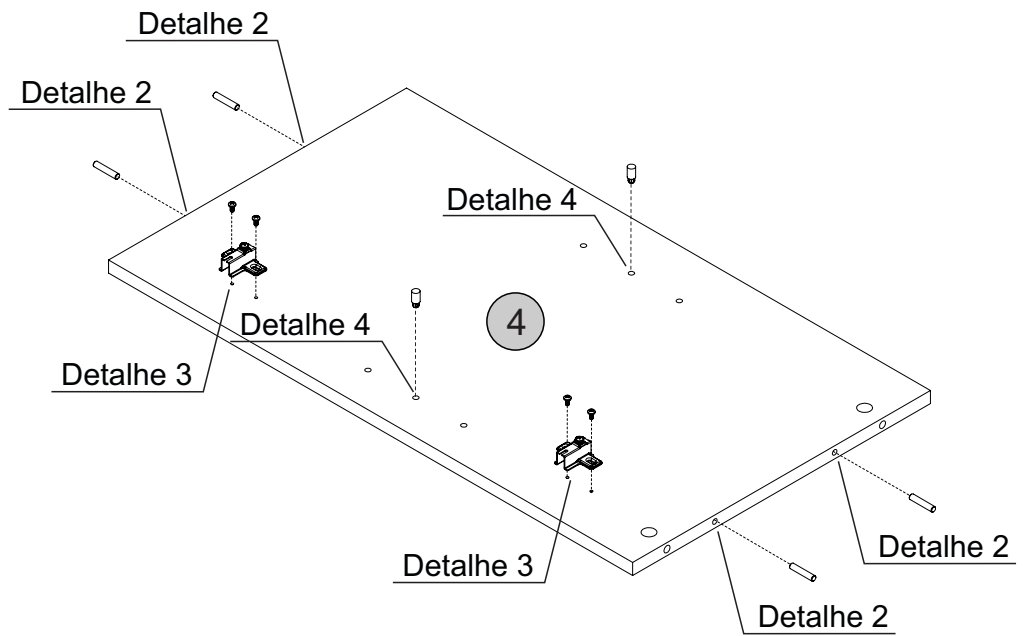
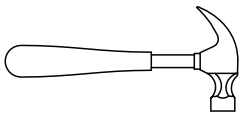
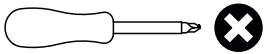

Detalhe 2
Detalle/Detail

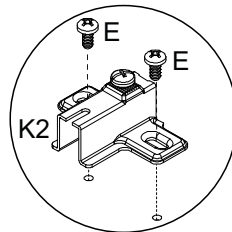

Detalhe 3
Detalle/Detail

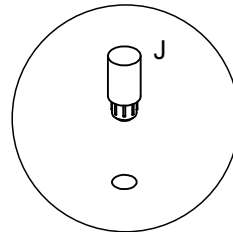

Detalhe 4
Detalle/Detail

Passo 4

Paso/Step

PEÇA
Pieza/Piece

5 - LATERAL ESQUERDA x1

FERRAGEM
Herraje/Hardware

A  04

B  02

FERRAMENTA
Herramienta/Tool

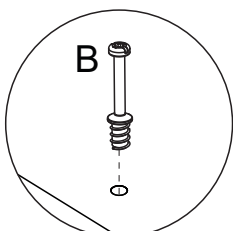
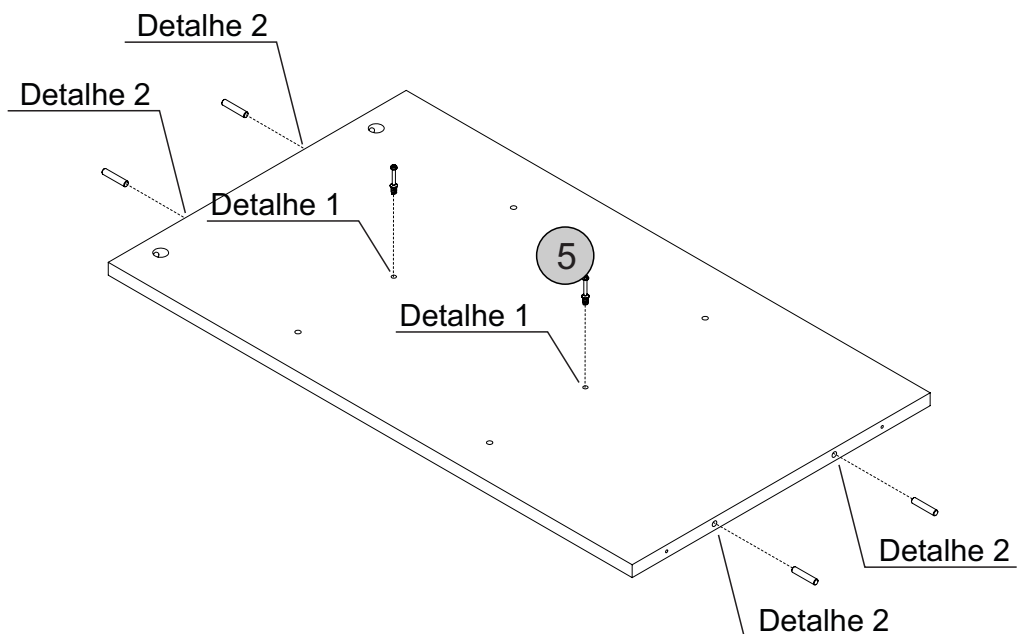
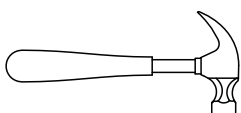
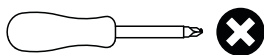

Detalhe 1
Detalle/Detail

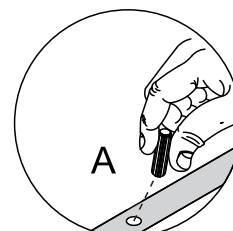

Detalhe 2
Detalle/Detail

Passo 5

Paso/Step

PEÇA
Pieza/Piece

10-DIVISÃO x1

FERRAGEM
Herraje/Hardware

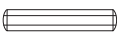
A  04

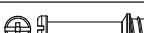
B  02

FERRAMENTA
Herramienta/Tool

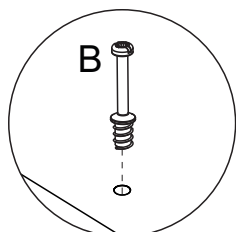
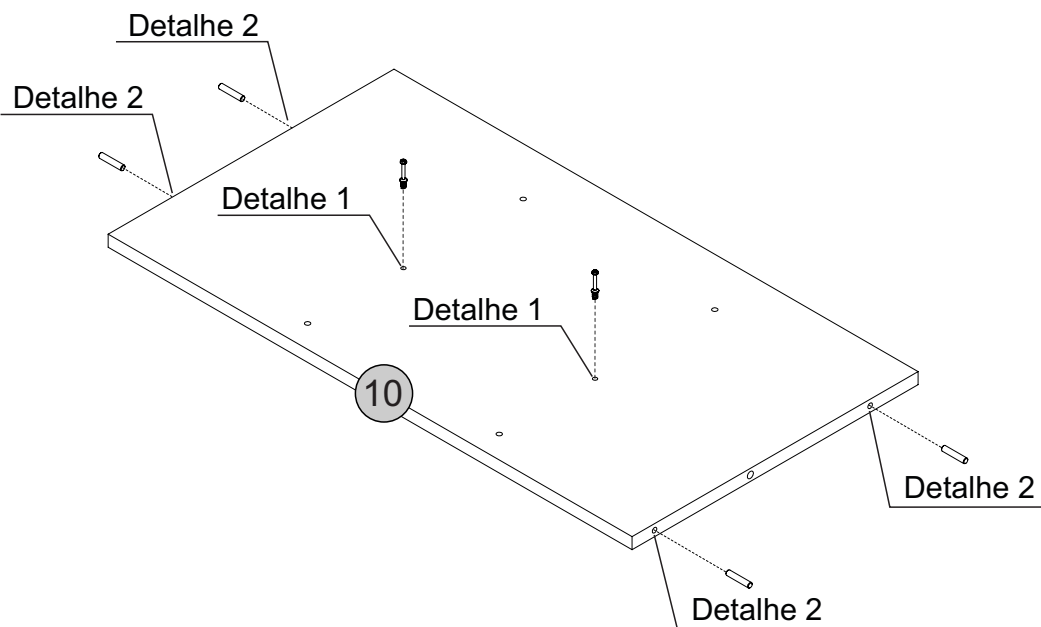
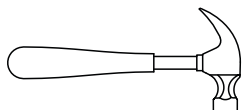
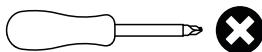

Detalhe 1
Detalle/Detail

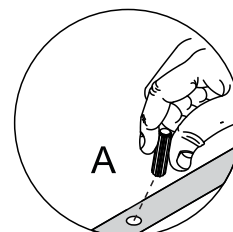
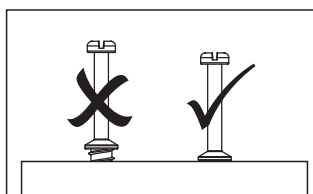

Detalhe 2
Detalle/Detail

Passo 6

Paso/Step

PEÇA
Pieza/Piece

10 - DIVISÃO x1

FERRAMENTA
Herramienta/Tool

J  02

FERRAMENTA
Herramienta/Tool

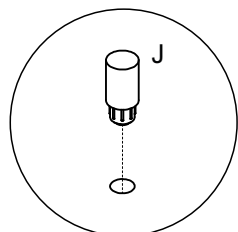
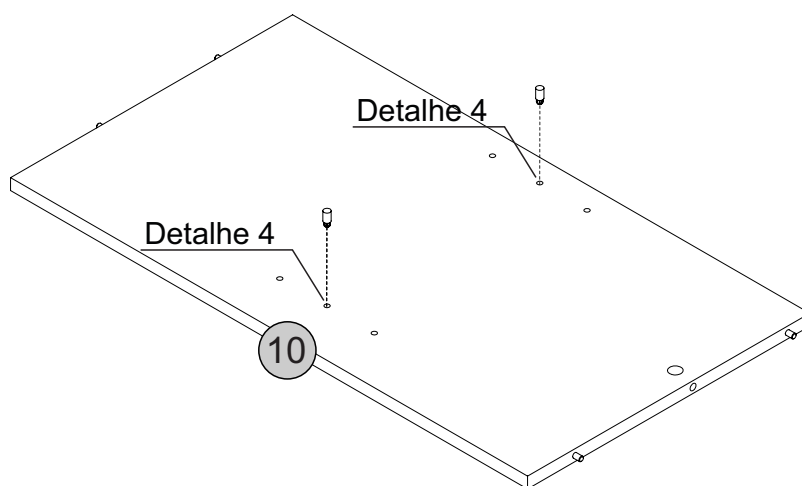
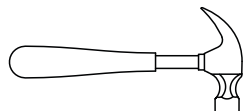

Detalhe 4
Detalle/Detail

Passo 7

Paso/Step

PEÇA
Pieza/Piece

7 - PORTA x1

8 - ALMOFADA/APLIQUE x1

FERRAGEM
Herraje/Hardware

E  10

P  10

FERRAMENTA
Herramienta/Tool

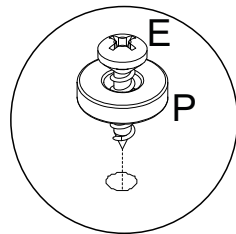
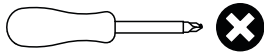

Detalhe 5
Detail/Detalle

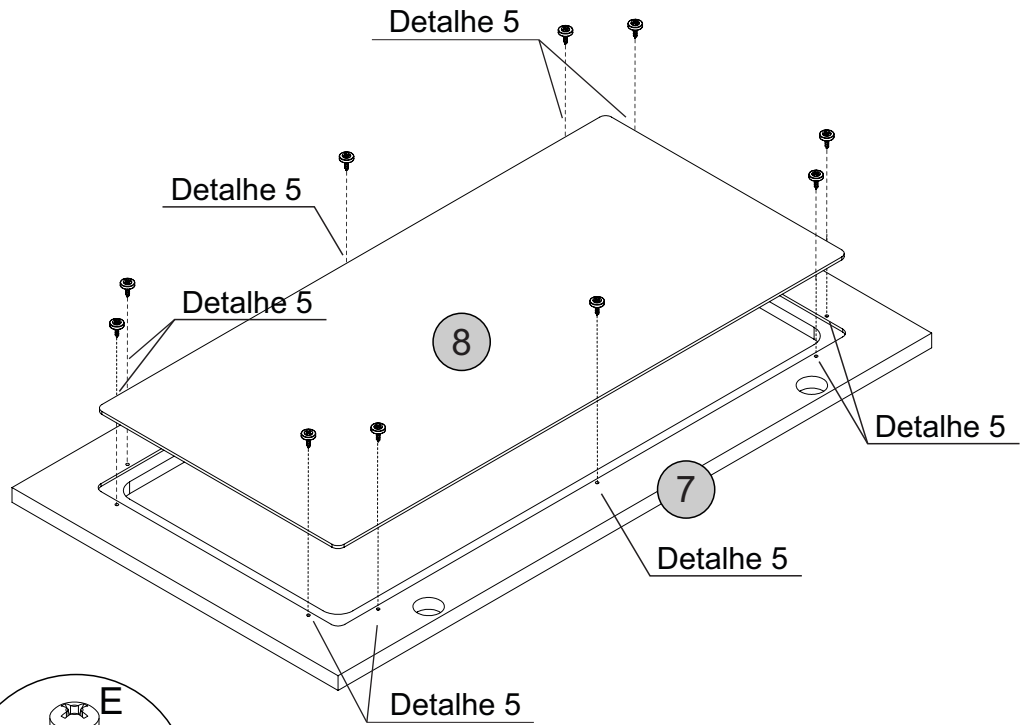

Passo 8

Paso/Step

PEÇA
Pieza/Piece

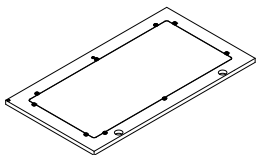

FERRAGEM
Herraje/Hardware

E  04

K1  02

FERRAMENTA
Herramienta/Tool

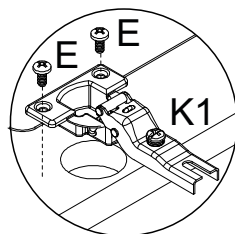
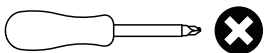

Detalhe 6
Detail/Detalle

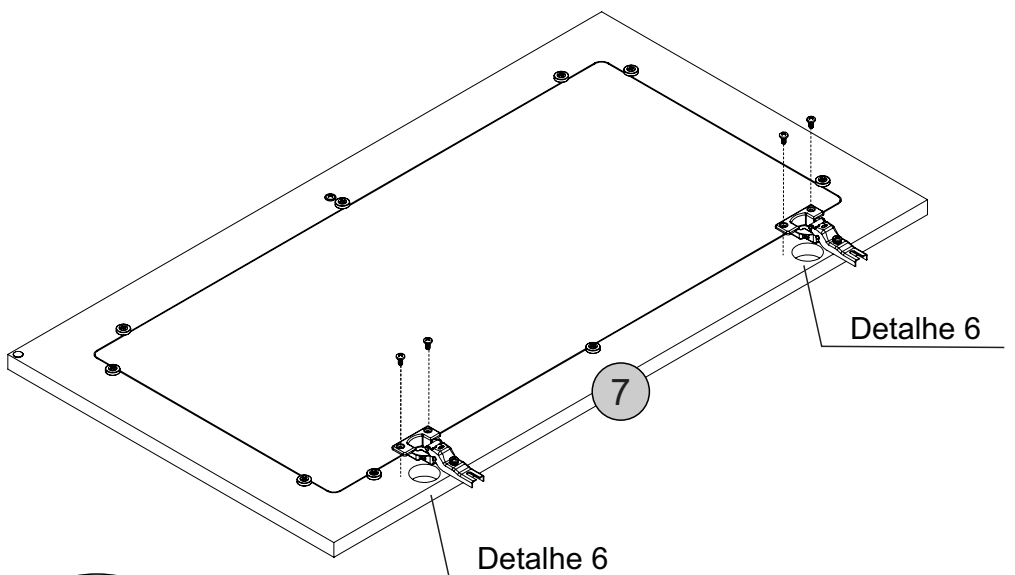

Passo 9



Paso/Step

PEÇA
Pieza/Piece

3 - PRATELEIRA x2

10 - DIVISÃO x1

FERRAGEM
Herraje/Hardware

C   02

FERRAMENTA
Herramienta/Tool

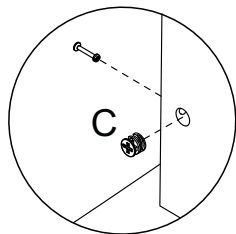
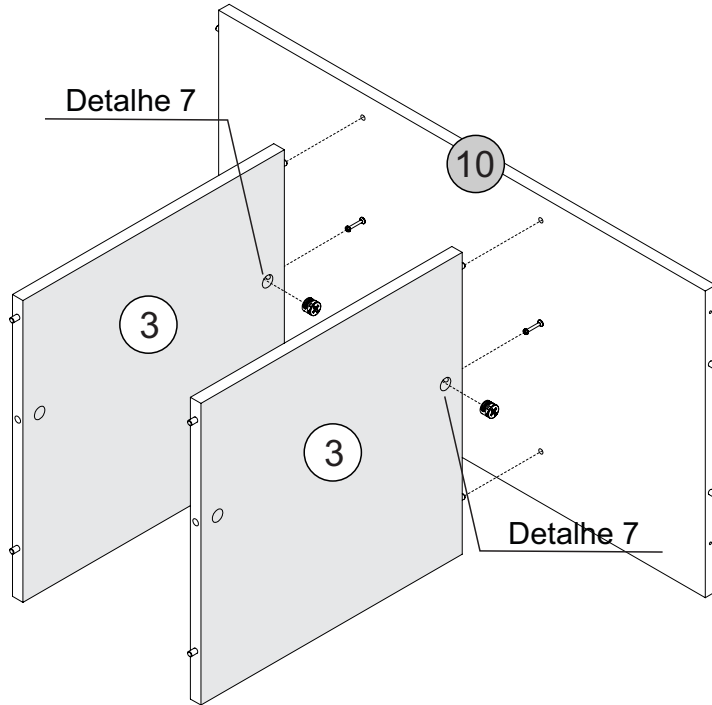
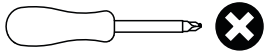

Detalhe 7
Detalle/Detail

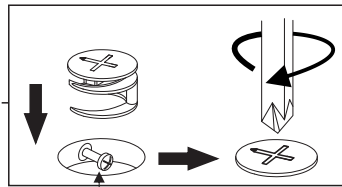

Cabeça do parafuso precisa estar no centro
La cabeza del tornillo debe estar en el centro
Screw head has to be in the center

Passo 10



Paso/Step

PEÇA
Pieza/Piece

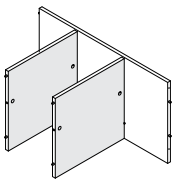
5 - LATERAL ESQUERDA x1



FERRAMENTA
Herramienta/Tool

C   02

FERRAMENTA
Herramienta/Tool

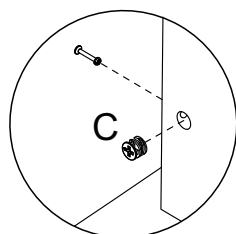
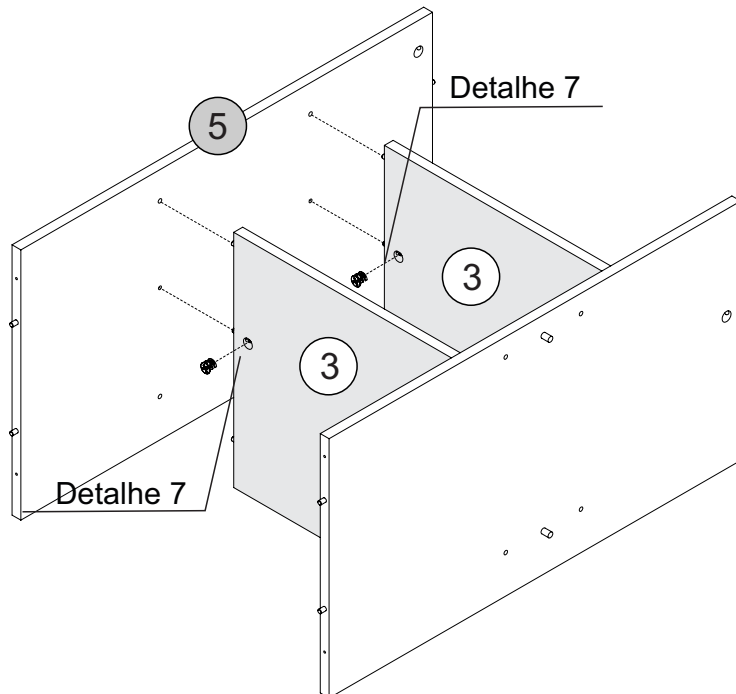
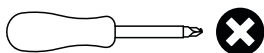

Detalhe 7
Detalle/Detail

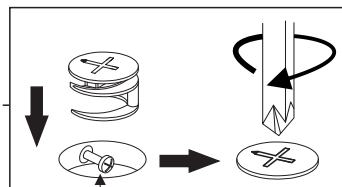

Cabeça do parafuso precisa estar no centro
La cabeza del tornillo debe estar en el centro
Screw head has to be in the center

Passo 11

Paso/Step

PEÇA
Pieza/Piece

2 - BASE x1

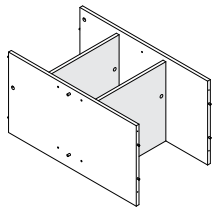

FERRAGEM
Herraje/Hardware

G  04

FERRAMENTA
Herramienta/Tool

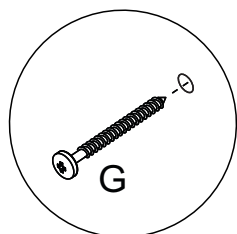
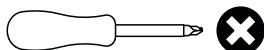

Detalhe 8
Detalle/Detail

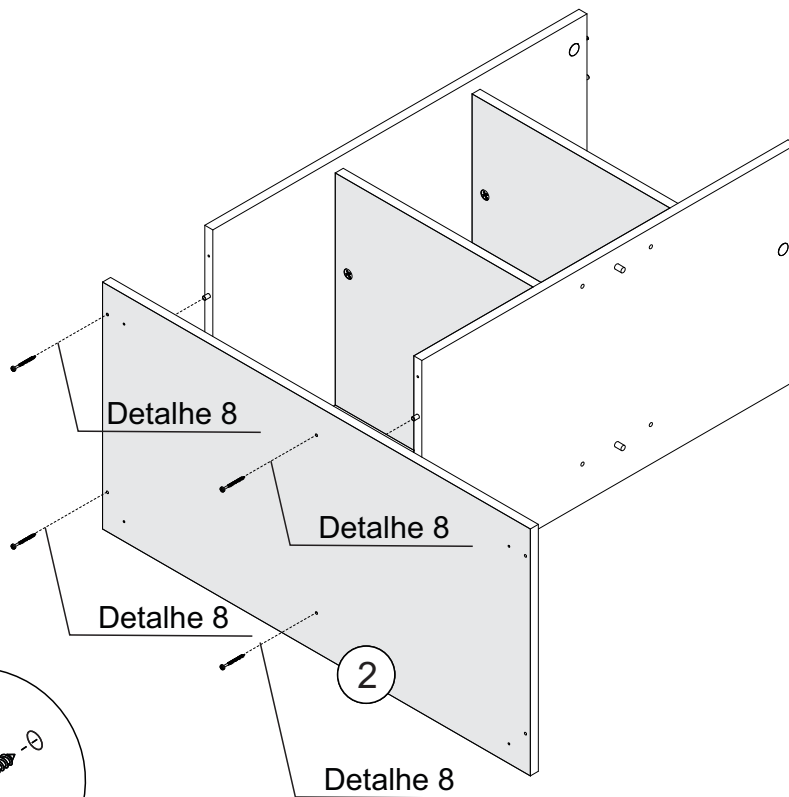

Passo 12

Paso/Step

PEÇA
Pieza/Piece

4 - LATERAL DIREITA x1

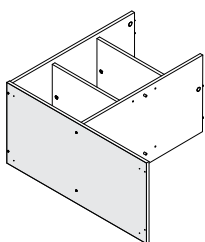

FERRAMENTA
Herramienta/Tool

G  02

FERRAMENTA
Herramienta/Tool

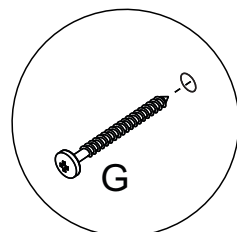
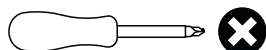

Detalhe 8
Detalle/Detail

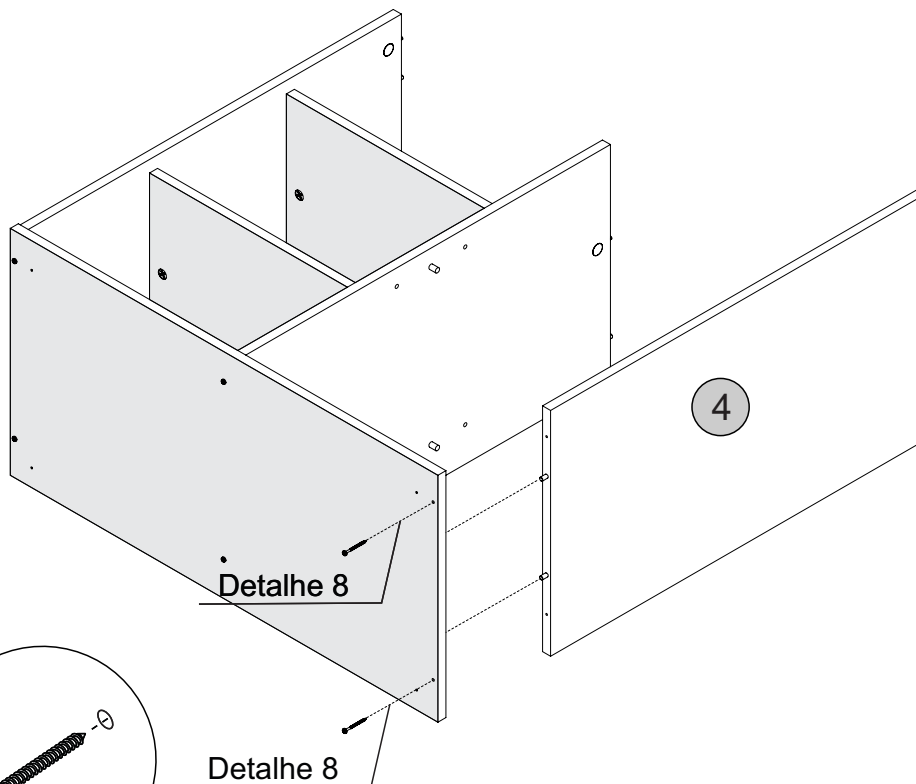

Passo 13

Paso/Step

PEÇA
Pieza/Piece

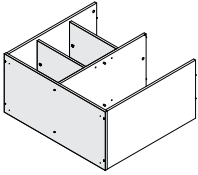

FERRAGEM
Herraje/Hardware

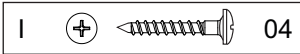
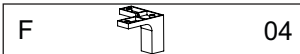
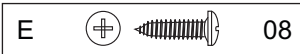

FERRAMENTA
Herramienta/Tool

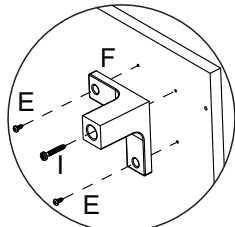
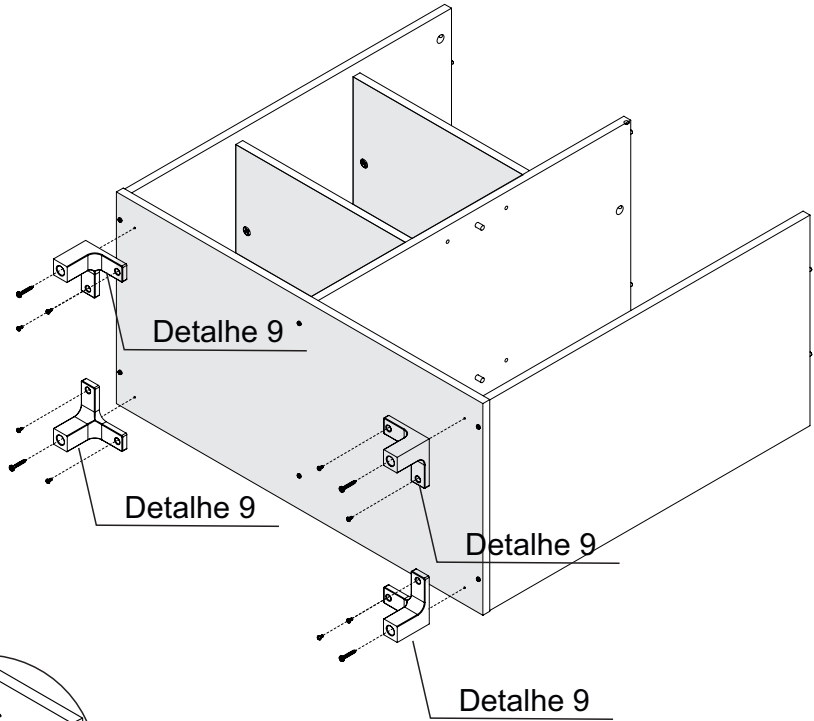
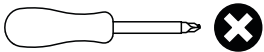

Detalhe 9
Detalle/Detail

Passo 14

Paso/Step

PEÇA
Pieza/Piece

1 - TAMPO x1

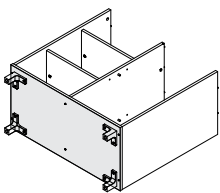

FERRAMENTA
Herramienta/Tool

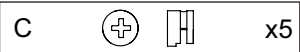

FERRAMENTA
Herramienta/Tool

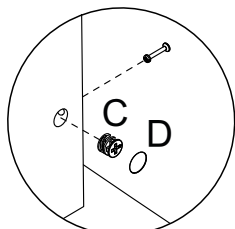
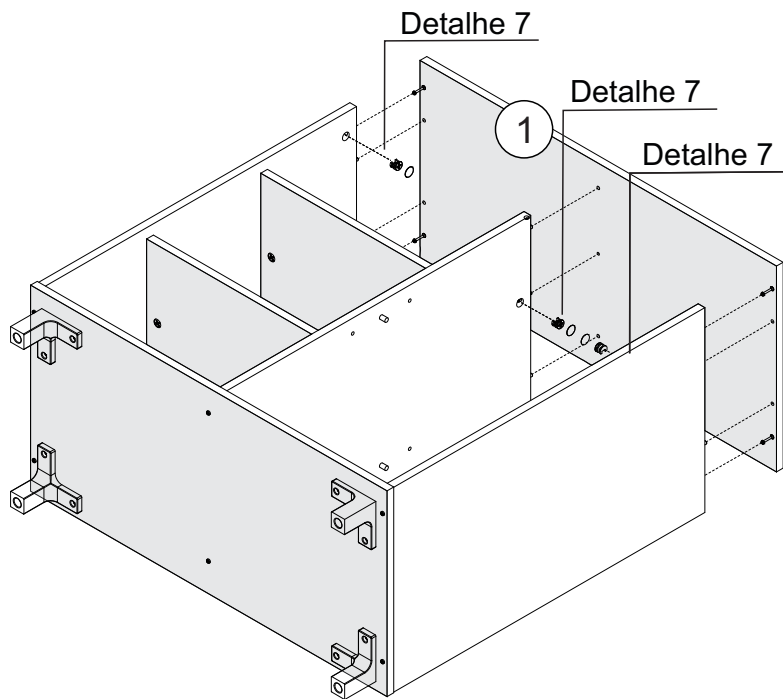
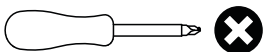

Detalhe 7
Detalle/Detail

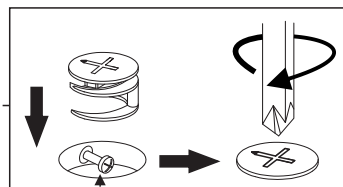

Cabeça do parafuso precisa estar no centro
La cabeza del tornillo debe estar en el centro
Screw head has to be in the center

Passo 15

Paso/Step

PEÇA

Pieza/Piece

9 - TRASEIRO x2

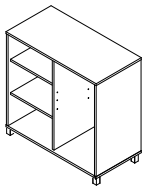

FERRAGEM

Herraje/Hardware

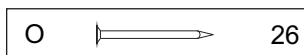

FERRAMENTA

Tool/Herramienta

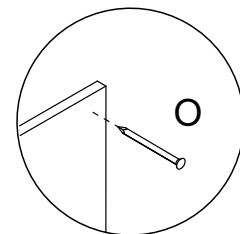
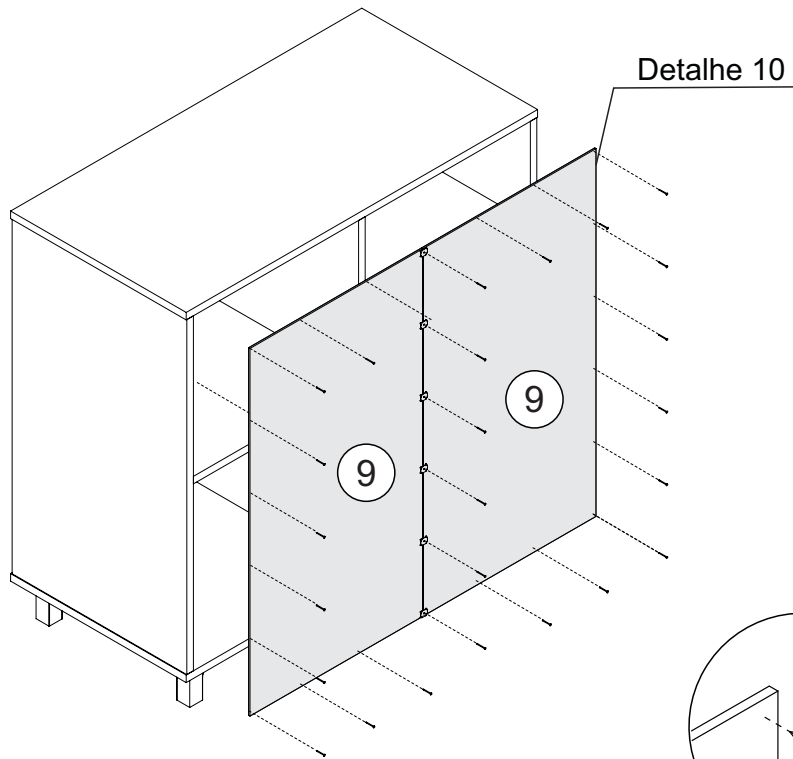
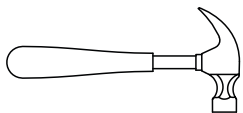

Detalhe 10
Detail/Detalle

Passo 16

Paso/Step

PEÇA

Pieza/Piece

6 - PRATELEIRA MÓVEL x1

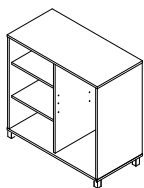

FERRAMENTA

Herramienta/Tool

FERRAMENTA

Herramienta/Tool

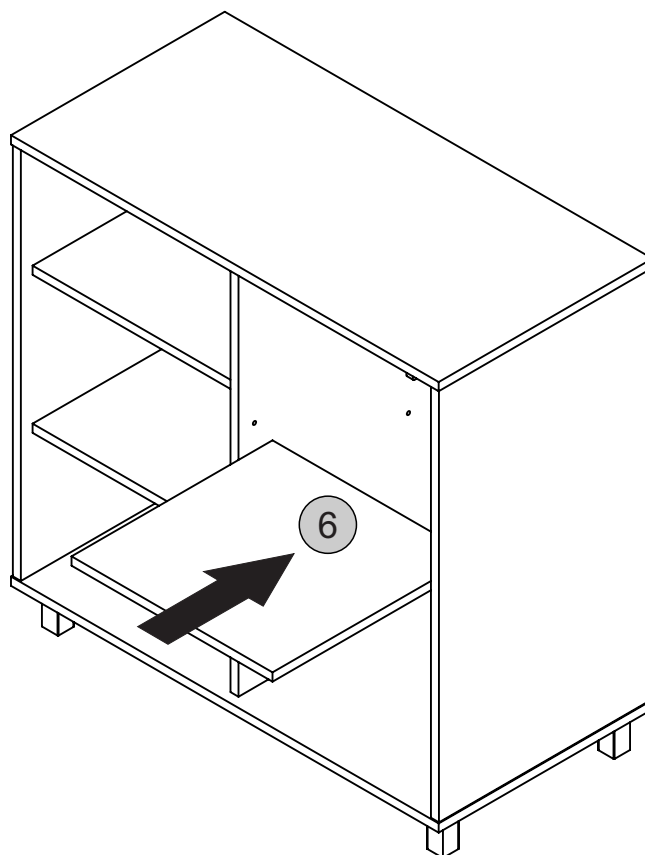

Passo 17

Paso/Step

PEÇA
Pieza/Piece

7 - PORTA x2

FERRAGEM
Herraje/Hardware

H  01

M  01

FERRAMENTA
Herramienta/Tool

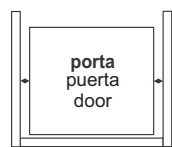
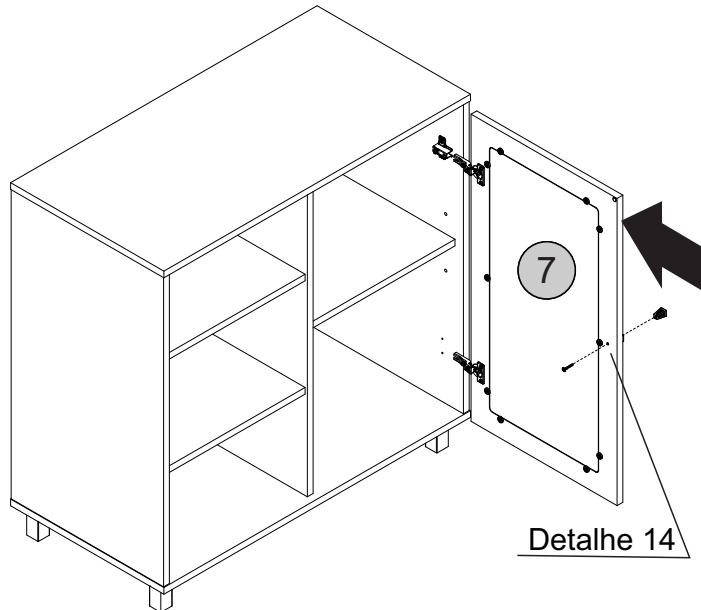
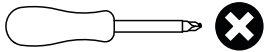

Ajuste de Largura
Ajuste de ancho
Width Adjustment

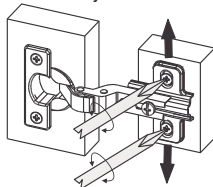

Ajuste Interno
Ajuste Interno
Internal Adjustment

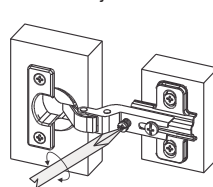

Ajuste de Profundidade
Ajuste de profundidad
Depth Adjustment

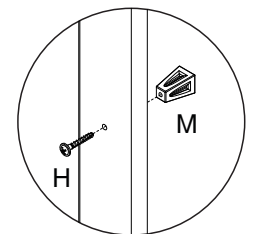
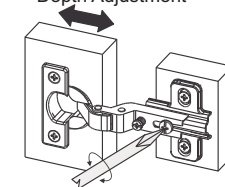

Detalhe 14
Detalle/Detail



Parabéns, você montou seu móvel! Agora é só decorar sua casa e aproveitar!

Queremos ver como ficou o móvel Artely do seu jeito... Marque a gente com a #meuartely. Ficaremos felizes em compartilhar!

Ah, e se tiver qualquer dúvida, sugestão ou comentário, entra em contato com a gente pelo nosso site www.artely.com.br.

¡Congratulaciones, montaste tu mueble! ¡Ahora solo decora tu casa y disfruta!

Queremos ver este producto en tu hogar, a tu manera... Utilice #meuartely, ¡ficaremos encantados de compartir tu foto!

Si tienes alguna duda, sugerencia o comentario, contáctenos a través de nuestro sitio web www.artely.com.br.

Congratulations, you've assembled your new furniture! Decorate your home and enjoy!

We want to see how this product is in your home... Use #meuartely, we will be happy to share your picture!

If you have any doubt, suggestion or comment, get in touch with us through our website www.artely.com.br.

